

Concord Express User's Guide

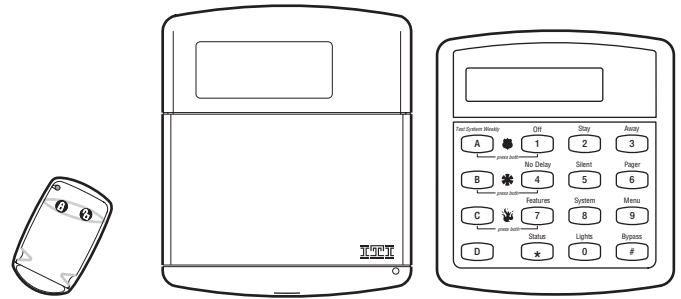



466-1667 Revision B

Getting to Know Your Security System	3	Auxiliary Panic Alarm	10
Overview	3	Siren Time-out	10
Communicating with the Panel	3	Access Codes	10
Instructing the Panel	4	System Master Code	10
How Your System Communicates with You	4	Regular User Codes	10
Fire and Smoke Alarms	4	Using the Programming Menus	10
Clearing Smoke Sensors	4	Programming Access Codes	10
What Happens When There is an Alarm	4	Setting the Time and Date	11
Arming Your System	4	Adjusting System Sounds and Touchpad Brightness	11
Level 1—OFF	4	Arming Your System Silently	11
Arming Level 2—STAY	5	Adjusting the Touchpad Beeps	12
Arming Level 3—AWAY	5	Adjusting the Touchpad Display Brightness	12
Keychain Touchpad Arming	5	Notification by Pager	12
Quick Arm	5	Pager Messages	12
Quick Exit	5	Streamlining the Page	13
Using the Chime Feature	6	Opening and Closing Reports	13
Preventing Accidental Alarms	6	Latchkey Paging	14
Exit and Entry Delay Times	7	No Activity Feature	14
Extended Delay	7	Using the Panel Download Feature	14
Exit Extension	7	System Information	14
No Delay—For Instant Alarm	7	Testing the System	15
Auto STAY Arming Feature	8	Automatic Test Features	15
Arming While a Door or Window is Open	8	Manual Tests	15
Bypassing a Sensor Directly	8	Troubleshooting	16
Bypassing a Sensor Indirectly	8	Trouble Beeps and Trouble Messages	16
Was the Bypass Successful?	8	Appendix A: User Sheets	18
Checking the Status of Your System	9	Appendix B: Planning for Emergencies	21
Short System Status	9	Appendix C: Programming Menus	23
Full System Status	9	Index	31
System Alarm Sounds	9		
Panic Alarms	9		
Fire Panic	9		
Police Panic Alarm	9		

Commands at a Glance

To do this:

Press:

Disarm the system. Cancel an accidental alarm.	1 + Code
Arm to Level 2—STAY.	2 + Code
Arm to Level 3—AWAY.	3 + Code
Send a police alarm.	 Press and hold both POLICE buttons for 2 seconds.
Send an auxiliary alarm.	 Press and hold both AUXILIARY buttons for 2 seconds.
Send a fire alarm.	 Press and hold both FIRE buttons for 2 seconds.
Arm system with No Delay.	2 + Code + 4 or 3 + Code + 4
Arm system to send a Latchkey page.	2 + Code + 6 or 3 + Code + 6
Bypass a sensor.	<i>Indirectly:</i> 2 + Code + # or 3 + Code + # <i>Directly:</i> # + Code + Sensor Number
Arm system silently.	5 + 2 + Code or 5 + 3 + Code
Check the system status.	*
Turn Chime on/off.	7 + 1
Check alarm memory.	7 + 6
Initiate a phone test.	8 + Code + 2
Initiate a sensor test.	8 + Code + 3

GETTING TO KNOW YOUR SECURITY SYSTEM

This manual describes how to operate your system. It describes basic arming and disarming commands as well as how to program system features.

The dealer or installer may have already discussed the details of your system with you. Record your system details in the User Sheets located in Appendix A.

Overview

Your security system is made up of different parts. Each plays a special role in the system's operation:

The **panel** is at the heart of your system. It stores the intelligence to monitor all the sensors and devices in the system. The panel is the piece of equipment that activates sirens and initiates a call to the central station in an alarm situation.

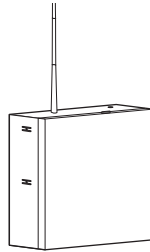

Touchpads are used to arm, disarm, and program your system.

Your system may use a wall-mounted touchpad that looks like this:

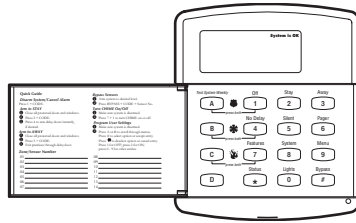

Or this:

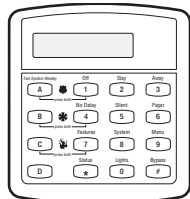

The first touchpad is called a fixed English touchpad. It communicates by using lighted text and an 11-character display. The second touchpad is called an alphanumeric touchpad and communicates by displaying text on a two-line display.

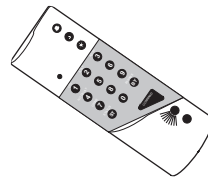

Your system may also use wireless, handheld touchpads that can be carried from room to room.

Keychain touchpads are also wireless and are handy for simple arming and disarming functions. Keychain touchpads can be carried off-site.



The installer can program the keychain touchpad to send a Police or Auxiliary panic alarm.

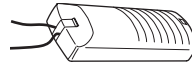

Wireless panic button touchpads are dedicated to sending one signal only—usually a Police or Auxiliary panic alarm. Panic button touchpads are usually kept near the user.

Door and window sensors protect the perimeter of your home by alerting the panel when a door or window is opened.

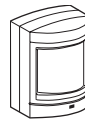
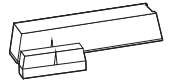

Motion detectors in hallways or rooms detect a person moving across the field of detection.

Environmental sensors such as smoke and heat detectors remain alert for the presence of fire or carbon monoxide 24 hours a day.



COMMUNICATING WITH THE PANEL

Your system can be set up to communicate with you through:

- Status beeps
- Alarm sirens
- Touchpad text
- Pager information

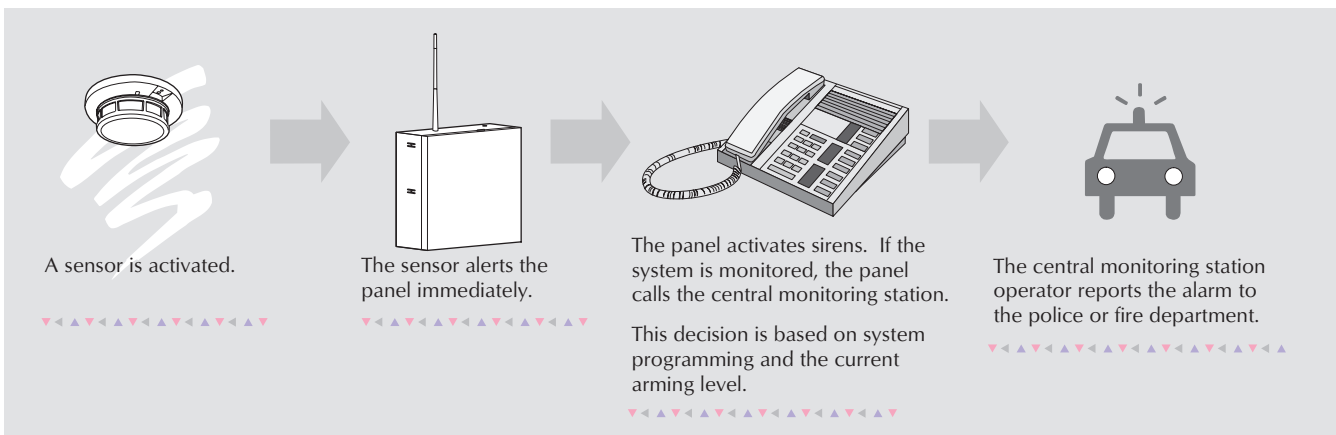

Instructing the Panel

Not just anyone can walk up to a touchpad and operate your security system. Before the system will process most commands, users are required to enter a pre-programmed 4-digit access code. Access codes are discussed in detail on page 10.

Command + Access Code

Keychain touchpads that are enrolled as part of the system do not require an access code, but are usually kept in an individual's pocket or purse.

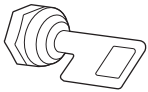

If you would rather use an actual key to arm and disarm the system, your security dealer can install a special key and keyswitch in your home.

How Your System Communicates with You

Touchpads and interior sirens produce a variety of operating beeps to inform you of different system states and operations.

Key Beeps

A Key beep is the tone you hear when you press a button on a touchpad. The sound confirms that the button was pressed adequately. Key beeps can be turned on or off by the installer.

Status Beeps

Status beeps from touchpads or sirens sound when there is a change in the current status of the system. Status beeps are not alarms, but they do warrant your attention.

There is more than one type of Status beep:

- Exit Delay beeps indicate that an arming command has been entered and the countdown to arming has begun.
- Entry Delay beeps indicate that you've entered the building and the countdown to an alarm has begun. (So disarm the system as soon as you get in!)
- Trouble beeps tell you that there is a problem with the system or one of its components.
- Chime feature beeps tell you that a door was opened.
- Protest beeps inform you that you're trying to arm the system while there is an open door or window.
- Sensor test beeps are the sound the system makes during a sensor test to indicate that a sensor was tested properly.

Status beeps are described in more detail throughout the manual.

Pager Notification

Your system can dial the phone numbers of three different pagers to notify pagerholders of events they may want to be aware of. Some of the events include:

- when the system is disarmed,
- when the system is armed,
- trouble conditions in the system, and
- alarm conditions.

For more information, see "Notification by Pager" on page 12.

What Happens When There is an Alarm

In the event of an alarm, several things happen at once:

- Sirens and hardwired touchpads emit emergency tones
- Panel notifies the central station for help.*
- Message appears on fixed English or alphanumeric touchpads.

* *Your system may or may not be monitored.*

If it is not monitored, no call will be made.

ARMING YOUR SYSTEM

Since your security needs may vary throughout the day, the system was designed with three arming levels. By arming your system to a particular level, only those sensors programmed to detect in that arming level will report alarms.

Level 1—OFF

Use Level 1 when intrusion detection is not necessary. For example, on an active Saturday morning—kids playing inside and out; someone working in the garage; various house projects going on.

Even though Level 1 disarms the system, your system continues to monitor for fire, smoke, carbon monoxide, and/or panic alarms if your system has these devices installed.

Here are some other situations in which you'd set the system to Level 1—OFF:

- *Upon entering your armed home or business.* When entering the armed premises through a designated delay door, the entry delay time begins. Entry Delay beeps remind you to disarm the system.
- *Before opening a door or window while inside or outside the armed home or business.* When you wake up in the morning and want to get your newspaper, you must disarm the system before opening the door to prevent an accidental alarm.

FIRE AND SMOKE ALARMS

If your system contains smoke and fire sensors, it monitors the premises for smoke and fire alarms 24 hours a day and in all arming levels.



These alarms cannot be cancelled or aborted and are *always* reported to the central station. Since many communities charge for dispatching the fire department in error, your dealer may give you specific instructions to follow in the event of an accidental

smoke or fire alarm. Record these instructions in the Appendix A User Sheets under "Accidental Smoke and Fire Alarms."

Clearing Smoke Sensors

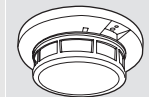
Once a smoke sensor has been in alarm, it is considered "Open" or in "Trouble" until it is reset:



- Press  + Code, once to silence the alarm.
- Press  + Code, twice to reset the smoke alarm.

(See the section on “Preventing Accidental Alarms” on page 6 if you would like to be able to leave quickly when the system is armed.)

- **To stop sirens and cancel an alarm.** When an alarm condition occurs, disarming the system turns off any sirens.

To disarm to Level 1—OFF using a touchpad:

1. Press **[1]**. Touchpads display “Enter Code.”
2. Enter your access code. Touchpads display date and time or programmed text.
3. The system sounds one long beep.

Arming Level 2—STAY

There are times when you want intrusion protection, but still want the freedom to move around within your house without setting off an alarm. For example, in the evening when your family is inside for the night. In this and similar situations, arm your system to 2—STAY.



KEYCHAIN TOUCHPAD ARMING

To disarm your system with a keychain touchpad, press the Unlock button.



Your installer can set up your keychain touchpad to arm the system in one of two ways:



1. Press the Lock button to arm the system directly to Level 3 with no Exit delay. Using this method, you would not be able to arm to Level 2.
2. Press the Lock button to increase the arming level each time it is pressed (Level 1 to Level 2, or Level 2 to Level 3). The Exit delay time would be applied.

QUICK ARM

Your system may be set up so that you're able to arm the system without using an access code.

To use Quick Arm:

- Increase the arming level by simply pressing **[2]** or **[3]** at any touchpad.

Decreasing the arming level requires that the user enter a code.



Simply press **[2]** or **[3]** to increase the arming level. To decrease the arming level, you'll need to enter an access code.



Contact your dealer if you'd like to use this feature.

To arm to Level 2—STAY using a touchpad:

1. Close all protected perimeter doors and windows.
2. Press **[2]** at any touchpad. Touchpads display, “Enter Code.”
3. Enter your access code. Touchpads display, “Armed to STAY.”
4. The system sounds two short beeps.
5. If leaving the premises, exit through a designated delay door immediately.

Arming Level 3—AWAY

At other times, you want every sensor to be alert: When the family is away from home, or, in a business, after closing time.

In this and similar situations, set your system to 3—AWAY for maximum protection. All sensors are active—perimeter door and window sensors, and interior motion detectors.

To arm to Level 3—AWAY using a touchpad:

1. Close all perimeter doors and windows.
2. Press **[3]** at any touchpad. Touchpads display, “Enter Code.”
3. Enter your access code. Touchpads display, “Armed to AWAY.”
4. The system sounds three short beeps.
5. Exit through a designated delay door immediately.

QUICK EXIT

Note: In UL Listed systems, this feature is disabled.

Your system may be set up so that when your system is armed to Level 2—STAY, you're able to press **[D]** on any touchpad and simply walk out of the door without having to disarm and rearm the system.

This is useful when your system is armed and you want to quickly pop outside to pick up the newspaper without disarming your system.

IMPORTANT: If you step outside and are planning to come back in, do *not* close the door behind you!

To use Quick Exit:

1. When the system is armed to 2—STAY, press **[D]** at any touchpad. Opening the door without pressing **[D]** will cause an alarm.
2. Open the door and go outside. *Leave the door open if you are planning to come back in!*
3. Come back in within two minutes and close the door. The system will rearm to 2—STAY.



In Level 2—STAY, simply press **[D]** before opening the door. The door must be closed again within 2 minutes to avoid alarm.



Contact your dealer if you'd like to use this feature.

USING THE CHIME FEATURE

Turning on the Chime feature is like having bells on every protected door and window. When this feature is on, sirens and speakers sound 2 beeps whenever anyone opens a protected door or window.

The Chime feature works only in Level 1—OFF.

To turn Chime on/off:

- While in Level 1—OFF, from any touchpad, press **[7]** + **[1]**. While the Chime feature is on, touchpads display, “CHIME ON” or “CHIME IS OFF.”

When the system is armed again, Chime becomes deactivated.

Chime-On-Close

The Chime-On-Close feature works like the regular Chime feature, but in addition to the double beeps heard upon opening a protected door or window, the system sounds one long beep when the door or window is closed again.

You can turn the Chime-On-Close feature on or off from the programming menu. Refer to Appendix C, “Programming Menus” for information on programming your system.

PREVENTING ACCIDENTAL ALARMS

Your security system is engineered with advanced technology that reduces the chance of an accidental alarm caused by a technical problem. In wireless systems, this technology prevents other devices, such as garage door openers, ham radios, television remote controls, and cellular phones, from interfering with your security system.

Most accidental alarms occur when leaving the house after arming the system, or upon returning, before disarming the system.

If, for example, you arm the system, then run upstairs for something you forgot, the Exit Delay time may expire. Once the Exit Delay expires, opening an armed door or moving in front of a motion detector will cause an alarm.

Aborting Accidental Alarms

Your system can be set up with the opportunity to abort an accidental intrusion, Police or Auxiliary alarm. (Fire alarms caused by smoke sensors, fire panic alarms, and heat sensors cannot be aborted.)

If the Dialer Abort feature is turned on, disarming the system (thus aborting the alarm), within a specified time period will silence the siren and prevent the alarm from being reported to the central monitoring station.

Aborting a fire alarm will silence the siren, however fire alarms are *always* reported. If an accidental fire alarm has sounded, follow the procedures of your central monitoring station to prevent a false dispatch.

To cancel an alarm:

- Press **[1]** + Code.

Guidelines for Preventing Accidental Alarms

Following these guidelines will go a long way toward preventing accidental alarms.

- ✓ Close doors and windows before you leave your house.
- ✓ When getting ready to leave the house, gather the things you want to take with you so you can exit immediately after arming the system.
- ✓ Always enter and exit within the programmed delay times.
- ✓ Make sure you leave through a door that has a delay time set for it. If you arm your system, then leave through a door without a delay time, an alarm will immediately sound.
- ✓ When you return, immediately disarm your system.
- ✓ Be aware of the devices in your security system and learn how each one operates.
- ✓ Listen to system beeps. Take note of any touchpad messages which indicate the system’s current status.
- ✓ If you have pets, ask your installer if you need pet lenses in your motion detectors. Pets climb higher than you may guess, causing alarms when you are away.
- ✓ Check the location of your smoke detectors. Smoke detectors near bathrooms can be tripped by steam from a shower. Smoke detectors near the kitchen can be tripped by cooking smoke.

Refer to the User Sheet in Appendix A to determine what the specific settings are for your system.

EXIT AND ENTRY DELAY TIMES



After arming your system, you need time to exit the building so you won't set off an alarm. Likewise, upon returning to your home or business, you'll need enough time to open the door and get to a touchpad to disarm the system.

- The *Exit Delay* is a period of time long enough to let you leave through a designated delay door after arming the system.
- The *Entry Delay* is a period of time long enough to let you unlock a designated delay door and get to a touchpad to disarm the system.

Exit Delay Example

You're about to go on an errand. You are inside your house and have just armed the system to Level 3—AWAY.

The interior sirens and touchpads sound three quick status beeps, telling you that the system accepted the command and has started the Exit Delay time.

During the Exit Delay time, the system sounds one short beep every 4 seconds. Exit the premises immediately.

During the last 10 seconds of the Exit Delay, you'll hear a three more quick status beeps. These beeps indicate that the Exit Delay has ended. Opening an armed door or window after the Exit Delay has expired will cause an alarm.



After arming, you'll hear 3 quick status beeps.

During the Exit Delay, you'll hear one beep every four seconds.
Leave the premises now.

3 quick status beeps sound before the system is armed.

Entry Delay Example

You are returning to your house that is armed to Level 3—AWAY. When you unlock and enter the designated delay door, the interior sirens and touchpads sound two short beeps every two seconds. This tells you that the Entry Delay time has begun and reminds you to disarm the system to avoid setting off an alarm.

During the last 10 seconds of Entry Delay, you'll hear one beep every second.

Your installer will work with you to decide which door(s) should be delay door(s), and determine the delay times that will work best for you and your family. Then, the installer will program the Exit and Entry Delay times into your system.



Upon entering, during the Entry Delay, you'll hear 2 beeps every 2 seconds.

Disarm the system before the last of 10 quick status beeps to avoid an accidental alarm.

Extended Delay

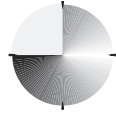

In some situations, additional time is needed to arm or disarm the system from, for example, a protected outside gate or door. In these instances, the installer can program an extended delay, giving as much as 16 minutes to exit or disarm the system before setting off an alarm.

Refer to the Appendix A User Sheets, "Delay Doors and Delay Time Settings," for a list of actual exit delay times.

Exit Extension

Note: In UL Listed systems, this feature is disabled.

Your system may be set up so that the delay time is restarted if you re-open the delay door during the initial delay time.

This is useful if, after arming the system, you walk out the door, then remember something you forgot inside. You can re-enter and exit through the delay door without disarming and re-arming the system.

Note: The Exit Extension will work on the first re-entry only.

If your system is not using this feature, you must disarm the system when you re-enter the armed premises to avoid setting off an alarm.

No Delay—For Instant Alarm



You can choose to turn off the Entry and Exit Delays, causing the delay doors to arm immediately. Anyone entering the house through the delay door when the system is set to No Delay would immediately cause an alarm.

No Delay is normally used:

- When you're staying at home, after you've armed the system.
- When you're arming and disarming your house from the outside. (You must have a wireless touchpad in order to do this.)

Arming to Level 2 or 3 with No Delay:

1. Close all perimeter doors and windows.
2. Exit the premises if arming to Level 3—AWAY.
3. Enter: **[2]** + Code or **[3]** + Code.
The system sounds two or three short beeps.
4. Immediately after hearing the beeps, press **[4]** for No Delay. Touchpads display, "Armed to STAY No Delay" or "ARMED TO AWAY NO DELAY," for example.

Changing the arming level will restore delay doors to their normal Exit and Entry Delay times.

Auto STAY Arming Feature

The Auto STAY Arming feature helps cut down on false alarms in the event that you arm the system to 3–AWAY, but fail to leave during the exit delay time. Here’s how it works:

<i>If you arm the system to Level 3–AWAY, and do not leave the premises within the exit delay time—</i>	
If feature turned on	The system can tell that no one opened and closed a delay door within the delay time. It assumes that someone is still inside and the panel will arm to 2–STAY to avoid a false alarm.
If feature turned off	The system arms to Level 3–AWAY regardless of whether or not a delay door has been opened and closed. Your movement inside the premises could activate a motion detector, causing an alarm.

Your dealer can turn this feature on or off for you.

ARMING WHILE A DOOR OR WINDOW IS OPEN

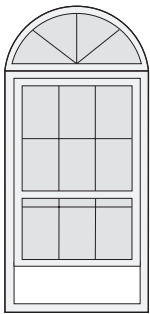

It is possible to arm your system while leaving a door or window open. This is useful if, for example, you like to sleep at night with the window open.

If the door or window has a sensor installed on it, the system must be told to ignore, or *bypass*, that sensor when it’s open. All other sensors will remain active.

There are two methods for bypassing a sensor:

- **Directly** — After arming the system, bypass door/window sensors *before* you open them. You must know the sensor number of the door or window you wish to bypass. To bypass directly, the user code must have been given the Direct Bypassing attribute. (See “Assigning the Direct Bypassing Attribute” on page 10.)
- **Indirectly** — As you are arming, bypass sensors on already-open doors and window. This method should not be used in UL-listed installations.

REMEMBER:



When a sensor is bypassed, you are allowing that door or window to be unprotected.

Bypassing a Sensor Directly

Use this method if the system is armed and you would like to open a window without disarming.

Refer to the Appendix A User Sheets to determine what the sensor number is for the sensor you wish to bypass.

To bypass sensors *directly*:

1. Close all doors and windows.
2. Arm your system to the desired level.
3. At any touchpad, press  + Code + sensor number. ( is labeled *Bypass*)
4. Touchpads display, “Bypassed Zones 01,” or “SENSOR 01 BYPASSED,” for example.
If the touchpad displays “INVALID,” or if the touchpad sounds one long beep, make sure that you entered a valid sensor number. Heat and smoke sensors cannot be bypassed.
5. Bypass other sensors, if necessary, by repeating Step 3.
6. The bypassed door or window can now be opened.

To arm bypassed sensors:

- Arm the system again.

Note: You cannot bypass sensors directly using a keychain touchpad.

Bypassing a Sensor Indirectly

Use this method if you are arming the system and would like to bypass doors and windows already open.

To bypass sensors *indirectly*:

1. Leave open only those doors and windows that are to remain open. Close all others.
2. Arm your system to the desired level. The touchpad emits protest beeps and displays “PROTEST,” because of the open sensor(s).
3. At any touchpad, press BYPASS. Touchpads with displays show, “Bypassed Zones 01,” or “SENSOR 01 BYPASSED,” for example.
4. The system sounds arming level beeps to indicate that the system is armed and open sensors have been successfully bypassed.

To arm bypassed sensors:

- Arm the system again.

To bypass sensors indirectly using a keychain touchpad:

- Press the Lock button once to arm the system and again to bypass open sensors:



Was the Bypass Successful?

To confirm whether or not a sensor was bypassed:

- Press the Status button on the touchpad. ( is labeled *Status*.)
Touchpads with displays list bypassed sensors or zones.

CHECKING THE STATUS OF YOUR SYSTEM

Checking the system status means finding out about the current condition of your system. This includes finding out if any sensors are open or currently bypassed, whether or not the AC power and backup battery are okay, the nature of the most recent alarm, and more, depending on the features in use and the equipment in your system.



Check the system status if:

- Your system sounds trouble beeps (five short beeps every minute).
- Your touchpads display, “Zones,” “POLICE,” “AUXILIARY,” and “FIRE.”
- Your touchpads display, “Press Status” or a blinking *.

Short System Status

A Short Status indicates the current arming level, sensor status (whether open or bypassed), low battery, supervisory, AC power or backup battery failures.

To get a Short System Status:

- Press . ( is labeled *Status*.)
The system sounds beeps according to the current arming level. (One for Level 1, two for Level 2, three for Level 3.)
Touchpads display the status information, for example: “System is OK,” or “SENSOR 02 OPEN.”



If an alarm or system trouble condition has occurred, it is displayed on a touchpad the first time you perform a Short or Full Status check. Performing a system status check a second time displays the system status including any trouble conditions.

If any alarm or system trouble is active, it continues to show up in every status check until the system is disarmed.

Full System Status

A Full Status combines the Short Status information with added details about specific system features.



To get a Full System Status:

- Press  + . Interior sirens sound beeps according to the current arming level. Touchpads display the status information, for example, “System is OK,” “SENSOR 03 BYPASSED,” “SYSTEM BATTERY IS OK,” “AC POWER IS OK.”

Note: A Full System Status is not available from the fixed English touchpad.

System Alarm Sounds

The sirens and touchpads in your system emit alarm sounds whenever an alarm occurs, either by a sensor or panic button activation. Each type of alarm sounds and reacts differently when activated, as described in the following table.

Type of Alarm	Alarm Sound
 Fire	Repeating series of three beeps
 Police	Continuous tone
 Auxiliary	Rapid beeps

PANIC ALARMS

Panic alarms are easily activated from any touchpad to quickly alert the central monitoring station to a Fire, Police, or Auxiliary emergency. A panic alarm can be activated at any time, regardless of the current arming level: 1—OFF, 2—STAY, or 3—AWAY.

This system is designed to inform a central monitoring station of the nature of the emergency so the correct personnel can be dispatched immediately.

Fire Panic

The Fire panic alarm sounds from all interior and exterior sirens. On monitored systems, the central monitoring station responds by calling the fire department.

To activate a Fire panic alarm from a touchpad:

- Press and hold both  Fire buttons for 2 seconds.



Police Panic Alarm

The Police panic alarm sounds from all interior and exterior sirens, scaring off any intruder and alerting neighbors to the trouble. On monitored systems, the central monitoring station responds by calling the police.

To activate a Police panic alarm using a touchpad:

- Press and hold the  Police button(s) for 2 seconds.

To activate a Police panic alarm from a keychain touchpad*:

- Press and hold the  Lock and  Unlock buttons at the same time for 2 seconds.

* The installer must configure the Police panic alarm to work this way.



✱ Auxiliary Panic Alarm

The Auxiliary panic alarm sounds from interior sirens only. It is typically set up by your security dealer, based on your specific needs. On monitored systems, the central station responds by calling the service or agency you specified through your dealer.

To activate an Auxiliary panic alarm from a touchpad:

- Press and hold the ✱ Auxiliary button(s) for 2 seconds.

To send an Auxiliary panic alarm from a keychain touchpad:

- Press and hold the  Lock and  Unlock buttons at the same time for 2 seconds.

Siren Time-out

If the system is not disarmed after an alarm, the sirens will continue to sound until the time-out period is reached. The time-out period can be programmed only by your installer or dealer.

Even though reaching the end of the time-out period stops the sirens, if your system is monitored, the central station will consider the alarm in progress until the system is manually disarmed.

ACCESS CODES

The system requires a valid access code before it will process most commands. The Appendix A User Sheets provide a location for you to record the System Master and User codes.

System Master Code

There is one System Master code. The System Master code is used to enter the programming menus for your system. The default System Master code is **1234**. It is important that you change the default code and record the new code in the Appendix A User Sheets.

Regular User Codes

There are 16 Regular User codes which act like keys to arm and disarm the system. If necessary, they can be assigned to neighbors, baby-sitters, or repair persons for temporary use. Regular user codes can be changed in the programming menus and are easily deleted from the system when no longer necessary.

Good User Code Hygiene

To preserve the integrity of your system, keep user codes confidential and delete extra codes as soon as they are no longer needed.



We recommend that you avoid using obvious code patterns such as **1234** or **1111**, **2222**, etc.



Using the Programming Menus

Some system settings can be changed by you, the user, while other settings must be changed by the installer.

To change system settings, you'll use the System Master code to enter a series of programming menus. Appendix C gives a detailed explanation of how to use the menus or, if desired, how to use programming shortcuts.

Programming Access Codes

User codes can be given certain attributes which determine whether the user can bypass a sensor or perform system tests.

Changing a User Code

To change or assign a user access code:

1. Enter the programming menus by pressing **9** + System Master Code.
2. Press **10** *nn* **0** where *nn* is user 00 through 15.
3. Enter the desired 4-digit code, then **#**.
4. ***** + **4** + **#** to exit the programming menus.

Note: The system will not accept the same code for two different users.

Erasing a User Code

When a code is deleted from the system, that code no longer acts as a key for operating the system in any manner.

To erase a user code:

1. Enter the programming menus by pressing **9** + System Master Code.
2. Press **10** *nn* **0** where *nn* is user 00 through 15.
3. Enter the System Master code, then **#**.
4. ***** + **4** + **#** to exit the programming menus.

Assigning the Direct Bypassing Attribute

Direct Bypassing is a user code attribute that allows the user to bypass open sensors. If the user code does not have this attribute turned on, the user will not be able to bypass sensors directly.

To assign Direct Bypassing to a user:

1. Enter the programming menus by pressing **9** + System Master Code.
2. Press **10** *nn* **1** where *nn* is user 00 through 15.
3. To turn Direct Bypassing:
 - on, press **2** + **#**.
 - off, press **1** + **#**.
4. ***** + **4** + **#** to exit the programming menus.

Assigning the System Test Attribute

System Tests is a user code attribute that allows the user to perform system tests. If the user code does not have this attribute turned on, the user will not be able to perform phone or sensor tests.

To assign the System Testing to a user:

1. Enter the programming menus by pressing **[9]** + System Master Code.
2. Press **[1][0] n n [2]** where *nn* is user 00 through 15.
3. To turn System Testing:
 - on, press **[2]** + **[#]**.
 - off, press **[1]** + **[#]**.
4. **[*]** + **[4]** + **[#]** to exit the programming menus.

The Touchpad Tamper Feature

The installer can program your system to send a Police alarm in the case of possible touchpad tampering.

If more than 40 keys are pressed when the system asks for a code, and those keystrokes are not part of a valid access code, a siren will sound.

SETTING THE TIME AND DATE

Although the installer usually sets the time and date at the time of installation, the user can change it when necessary. See Appendix C, "Programming Your System" for more detailed information on setting this feature.

To set the system time:

1. Enter the programming menus by pressing **[9]** + System Master Code.
2. Press **[0][0]**.
3. Enter the correct time in 24-hour format (4 digits), then press **[#]**.
For example, if the current time is 7:23 a.m., press **[0][7][2][3]** + **[#]**.
4. Press **[*]** + **[4]** + **[#]** to exit the programming menus.

24-Hour Format

00:00 = Midnight	06:00 = 6:00 am	12:00 = Noon	18:00 = 6:00 pm
01:00 = 1:00 am	07:00 = 7:00 am	13:00 = 1:00 pm	19:00 = 7:00 pm
02:00 = 2:00 am	08:00 = 8:00 am	14:00 = 2:00 pm	20:00 = 8:00 pm
03:00 = 3:00 am	09:00 = 9:00 am	15:00 = 3:00 pm	21:00 = 9:00 pm
04:00 = 4:00 am	10:00 = 10:00 am	16:00 = 4:00 pm	22:00 = 10:00 pm
05:00 = 5:00 am	11:00 = 11:00 am	17:00 = 5:00 pm	23:59 = 11:59 pm

To set the system date:

1. Enter the programming menus by pressing **[9]** + System Master Code.
2. Press **[0][1]**.
3. Enter the current date as 6 digits (*mm/dd/yy*) then press **[#]**.
4. Press **[*]** + **[4]** + **[#]** to exit the programming menus.

ADJUSTING SYSTEM SOUNDS AND TOUCHPAD BRIGHTNESS

Arming Your System Silently

Use the Silent Arming feature to arm your system without disturbing people throughout the house with arming status beeps. There are two methods for implementing Silent Arming:

- Silent on Demand (User presses **[5]** before arming.)
- Arming Always Silent (Silent Arming feature on.)

Regardless of the method employed, when Silent Arming is in effect, no Exit beeps sound.

Note: Protest beeps will always sound when bypassing a sensor.

Silent Arming on Demand

Pressing **[5]** before arming silences arming status beeps from touchpads and interior sirens.

To use Silent Arming on demand:

1. From any touchpad, press **[5]**.
2. Within 4 seconds enter: **[2]** + Code or **[3]** + Code.

Arming Always Silent

Turning this feature on in the programming menu means that the status beeps that come from touchpads and interior speakers while arming will *always* be silent. You will not have to enter **[5]** before arming, as with Silent Arming on Demand.

See Appendix C, "Programming Your System" for more detailed information on setting this feature.

To enable Silent Arming:

1. Enter the programming menus by pressing **[9]** + System Master Code.
2. Press **[2]** + **[1]**.
3. To turn Silent Arming:
 - on, press **[2]** + **[#]**. No system status beeps will sound while arming.
 - off, press **[1]** + **[#]**. System status beeps will sound from touchpad while arming.
4. Press **[*]** + **[4]** + **[#]** to exit the programming menus.

Adjusting the Touchpad Beeps

The frequency or pitch of chime and trouble beeps from each fixed English touchpad can be adjusted individually to a more desirable or distinct tone.

Chime and trouble beep tones sound using the default frequency during, or within 15 seconds of any button activity at that specific touchpad.

To change status tone pitch:

1. Press and hold the ***** and **0** until you hear a steady tone, then release the buttons.
2. Press and hold **1** to lower the pitch or press and hold **2** to raise the pitch.
3. Release the button when the desired pitch is heard.

After about 15 seconds of no touchpad activity, the steady tone stops sounding.

Adjusting the Touchpad Display Brightness

You may want to change the brightness of a touchpad display based on its location in a building or room. For example, dim the touchpad display in a bedroom or enhance a display near a window.

Changing the touchpad display affects only the touchpad currently being used.

To change touchpad display brightness:

1. Enter the programming menus by pressing **9** + *System Master Code*.
2. Press **2** + **2**.
3. Select a brightness level:
 - **0** + **#** Off
 - **1** + **#** Low
 - **2** + **#** Medium
 - **3** + **#** High
4. Press ***** + **4** + **#** to exit the programming menus.

After dimming the display, pressing any button momentarily returns the display to full brightness. After 15 seconds without touchpad activity, the display returns to the set dimmed level. If an alarm occurs while the display is dimmed, it automatically returns to the full brightness level and stays that way until you disarm your system.

NOTIFICATION BY PAGER

Your system can notify up to three different pager phone numbers to report system events. The installer can program any pager to receive pages for one or more of the following groups:

- High Level Reports, which includes the following reports:
 - Sensor alarms
 - Sensor Tamper
 - Sensor Restorals
 - Phone test
 - Receiver failure
 - Receiver jam
 - Touchpad tamper
 - Bus failures
 - No activity alarm
 - Fire panic
 - Police panic
 - Auxiliary panic
 - Duress alarm
- Low Level Reports, which includes the following reports:
 - Bypass sensors
 - Low battery
 - Sensor Supervisory
 - Trouble
 - Phone test
 - Touchpad supervisory
 - Touchpad low battery
 - Force armed (reports when a user bypasses sensors while arming system)
 - AC power fail
 - CPU low battery
 - Auto phone test
 - CPU back in service
 - Phone Failure
 - Event buffer full
 - Force armed
- Opening and Closing reports
- Latchkey Paging

Pager Messages

When an event is reported on a numeric pager, the following information is included:

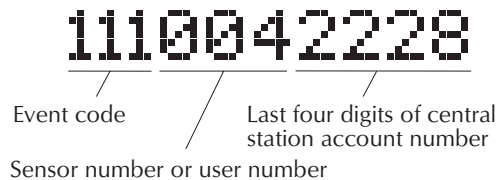

Although all three types of information can be reported on your pager, your pager service determines how the information will actually appear.

Event Code in Page

This part of the page let's you know *what* has happened.

Table 1. Event Codes in Pages

Code	Indicates
009	A sensor has been restored to its non-alarm state
111	System has been disarmed
118	System trouble has been fixed
119	System alarm condition has been cancelled
222	System armed to Level 2
333	System armed to Level 3
555	System phone test
888	System has a trouble condition
999	System is in alarm condition

Sensor Number or User Number in Page

This part of the page let's you know *who* or *what* is causing the event.

Table 2. Sensor Numbers or User Codes in Pages

Code	Indicates
000	System event not caused by a sensor or user
001 – 024	Sensor numbers 1 through 24
600 – 615	User codes 00 through 15 used
678	System Master code used
679	Installer code used
680	Dealer code used
697	Quick Arm used
698	Keyswitch sensor used
699	System armed itself because it is being serviced or powered-up

Account Number in Page

This part of the page let's you know *where* the event is occurring.

Table 3. Account Number

Code	Indicates
XXXX	4-digits of account number

Some pager providers transmit only numbers and not alpha-characters. If your account number contains alpha-characters, check with

your provider to see exactly how your account number will appear on your pager.

Streamlining the Page

If you feel that it is not necessary to see your account number with each page from your system, you may elect to have the Streamlining feature turned on. Your page will contain only an event code (Table 1) and a sensor or user number (Table 2).

Ask your dealer or installer if you would like the Streamline feature turned on.

Sample pager message with the Streamline feature turned on:

111004

/ /
Event code /
Sensor number or user number

OPENING AND CLOSING REPORTS

The Opening and Closing Reports feature allows up to three pagerholders and/or the central station to be notified whenever the system is armed and/or disarmed. Refer to the Appendix A User Sheets to see which pagers have been set up to receive a page for this feature.

The Opening and Closing Reports feature can be enabled only by the installer.

If the feature is on, pagerholders will receive:

- an Opening Report page every time the system is disarmed: 111 for Level 1–OFF, and the user code entered.
- a Closing Report page every time a user arms the system: 222 for Level 2 or 333 for Level 3, and the user code entered.

See “Notification by Pager” on page 12 for more information on paging reports.

LATCHKEY PAGING

The Latchkey paging feature allows up to three pagerholders to be notified when the system is disarmed. Latchkey pages do not report to the central station. This feature is useful when you're at work and would like to be notified when your daughter or son arrives home and disarms the system.

The Latchkey paging feature can be enabled only by the installer.

Refer to the Appendix A User Sheets to see which pagers have been set up to receive a Latchkey page.

Only Latchkey-designated user codes can cause a Latchkey page to be sent. By default, this includes the first 5 Regular User codes. If you'd like more user codes to be included, contact your installer.

Preparing the system to send a Latchkey page:

- Arm the system, then enter **[6]**. Touchpads display briefly: "Pager on," or "LATCHKEY PAGER ON."

To send a Latchkey page:

- Latchkey-designated user disarms the system. Pagerholders will receive a message containing *111* and the user code entered to disarm the system.

Note: If you have the Opening and Closing Reports feature turned on, you'll receive a page every time someone disarms the feature, not just Latchkey-designated user codes.

NO ACTIVITY FEATURE

The system can monitor the activity in your home and automatically call for help if normal activities are not detected within a defined period of time.

Note: This feature is not active in Level 3—AWAY.

For example, if someone falls and can't move, the system will detect that normal activities, such as opening doors and windows, have not occurred for a predetermined No Activity time.

The system sounds an auxiliary alarm to let you know there may be a problem. If all is well, you can stop the siren by disarming your system. If no one disarms the system for 5 minutes, your system calls the central monitoring station. The central monitoring station will send emergency personnel to the premises to check out the situation.

Refer to the Appendix A User Sheets to see if the No Activity feature is currently available to you and the duration of the No Activity setting. If the feature is not currently available to you, contact your installer.

USING THE PANEL DOWNLOAD FEATURE

To *download* to the panel is to replace the old information in it with new information. Downloading is performed only by your dealer using ITI software specifically designed for this panel.

Turning the Download feature on allows the dealer remote access to your panel in order to:

- Update your account.
- Back up data from your panel.
- Allow your dealer to quickly implement requested programming changes.

Note: Before allowing any download sessions, the system must be disarmed to level *1-OFF*.

To enable/disable the Panel Download setting:

1. Enter the programming menus by pressing **[9]** + *System Master Code*.
2. Press **[2]** + **[0]**.
3. To turn Downloading:
 - on, press **[2]**+ **[#]**. The dealer will be able to access your system remotely if necessary.
 - off, press **[1]**+ **[#]**. The dealer will not be able to access your system remotely.
4. Press **[*]** + **[4]** + **[#]** to exit the programming menus.

SYSTEM INFORMATION

There is information about your system that is useful to know. This includes the factory code, the system number, and the system level.

After identifying the information for your system, make a note of it in the Appendix A User Sheets.

To identify system information:

1. Enter the programming menus by pressing **[9]** + *System Master Code*.
2. Press **[B]** until the touchpad displays "System ID," or "SYSTEM VERSION," then press **[#]**.
 - The first information displayed is the factory code. For example, "FACTORY CODE *nnn* * *nnnn*," or "F *nnn* – *nnnn*."
 - Press **[B]** to display the system number. For example, "N – *nnnnnnn*," or "SYSTEM NUMBER * *nnnnnnn*."
 - Press **[B]** to display the system level. For example, "L *nnnn*," or "SYSTEM LEVEL *nnnn*."
3. Press **[*]** + **[4]** + **[#]** to exit the programming menus.

TESTING THE SYSTEM

The system contains a test mode that allows you to test sensors and panic signals without creating false alarms. Test your system weekly, by following the instructions in this section carefully.

Automatic Test Features

Your security system conducts routine tests, checking for problems like power failures, low batteries, sensors that aren't working, and communication trouble with the central monitoring station.

When your system detects a problem, trouble beeps sound to alert you. See "Troubleshooting" on page 16 for an explanation of the causes of trouble beeps and what you can do to fix the problem.

Manual Tests

The automatic tests your system performs provide continuing reassurance that it is working properly. There are also weekly system tests you can do yourself as an added safeguard. Taking time to do these tests will familiarize you with your system and alert you to anything unusual, such as cut phone lines or sensors that have been tampered with.

Sensor Test

This test verifies that the sensors in your system are operating correctly.

The ability to conduct a sensor test is a code attribute given per User code. Check the Appendix A User Sheets to see which access codes have the ability to conduct a sensor test.

Table 3. Sensor Test Procedure

1. Enter Test Mode by pressing [8] + Code + [3] .	Touchpads display, "Press Status. System Armed to Sensor Test," or " *SENSOR TEST nn MINUTES LEFT. " When less than 5 minutes remain to the Test Mode time, the system sounds a short beep every 60 seconds.
2. Follow the test procedure for each device.	

Device	Test procedure	Touchpad Result
Touchpads	Send a: Police panic alarm, Fire panic alarm, and Auxiliary panic alarm.	Touchpad Panic POLICE OK Touchpad Panic FIRE OK Touchpad Panic AUXILIARY OK POLICE PANIC OK FIRE PANIC OK AUXILIARY PANIC OK
Wireless Touchpads	Press the Bypass key.	Zones nn OK Touchpad nn OK
Keychain Touchpads	Press and hold the two assigned panic buttons simultaneously for 3 seconds.	Touchpad Panic POLICE OK Touchpad Panic AUXILIARY OK POLICE PANIC OK AUXILIARY PANIC OK
Panic buttons	Press and hold the appropriate panic button(s) for 3 full seconds.	Zones nn OK SENSOR nn OK
Door/window sensor	Open the secured door or window.	Zones nn OK SENSOR nn OK
Smoke detector	Press and hold the test button until the system sounds transmission beeps.	Zones nn OK SENSOR nn OK
Motion detector	Avoid the motion detector's view for 5 minutes, then enter its view.	Zones nn OK SENSOR nn OK
Rate-of-Rise Heat Detector (Not UL investigated)	Rub your hands together until warm, then place one hand on the detector for 30 seconds.	Zones nn OK SENSOR nn OK
Shock sensor (Not UL investigated)	Tap the glass twice, away from the sensor. Wait at least 30 seconds before testing again.	Zones nn OK SENSOR nn OK

Device	Test procedure	Touchpad Result
Glass guard sensor (Not UL investigated)	Tap the glass 3 or 4 inches from the sensor.	Zones <i>nn</i> OK SENSOR <i>nn</i> OK
Freeze sensor (Not UL investigated)	Apply an ice cube wrapped in plastic to the sensor. Do not allow the sensor to get wet.	Zones <i>nn</i> OK SENSOR <i>nn</i> OK
<ul style="list-style-type: none"> • If you need more time to complete testing, restart the timer by pressing 8 + Code + 3. • Check to see that all sensors have been tested by pressing [*]. Touchpads display a list of untested sensors. • You will know that you have finished testing when touchpads display, “SENSOR TEST OK” or “ZONES ALL TESTED.” 		
3. Disarm to Level 1 to exit Test Mode.		

Phone Communication Test

The purpose of this weekly test is to verify that the connection between the central monitoring station and your system is working properly.

Most phone tests take only a few minutes, however, your system will try for up to 15 minutes to establish a connection.

After the test has started, the arming level can be changed to Level 2—Stay or Level 3—AWAY.

To perform a phone communication test:

1. Contact the central monitoring station to inform them that you want to test the phone communication of your system.
2. Disarm the system.
3. Press **[8]** + System Master Code + **[2]**. The touchpad displays, “System Armed to PHONE TEST,” or “*PHONE TEST.”

On fixed English touchpads:

After the phone test is complete, the touchpad displays “PHONE TEST OK.” Press **[*]**.

- If the phone test is successful, the touchpad displays “System Phone Test Alarm Memory” or “Phone Test Memory” briefly, then returns to a normal text display. Press **[*]** a second time and the touchpad displays “System is OK.”
- If the phone test is *unsuccessful*, the touchpad displays “Memory Test Phone” briefly, then “Alarm Memory Phone Failure.”

On alphanumeric touchpads:

- If the phone test is successful, the touchpad display returns to a normal text display.
- If the phone test is *unsuccessful*, the touchpad displays “SYSTEM PHONE TEST ALARM,” then, “MEMORY,” and finally, “PHONE FAILURE ALARM MEMORY.”

If a phone test is unsuccessful, check to see if you hear a dial tone from phones in the house. Call your dealer if you hear a dial tone, but your phone test is unsuccessful.

Testing Sirens

The purpose of this weekly test is to verify that the panel is activating sirens with the appropriate warning sounds.

To perform an alarm siren warning sound test:

1. Contact the central monitoring station to inform them that you will be activating alarms and *they should not dispatch authorities*.
2. Activate alarms of each type (fire, police, auxiliary), one at a time.
3. Listen for the appropriate siren sound when each alarm is activated (see “Alarm Sound” table on page 9).
4. Contact the central monitoring station to inform them that you are finished activating alarms.

TROUBLESHOOTING

Your security system uses a variety of different alarm sirens, status beeps, and trouble beeps to communicate with you. The next few pages describe the different sounds and what they mean. Try to familiarize yourself with the differences. You will hear some sounds each time you tell your security system to do something, like arm or disarm. Some sounds you will hear only when there is a problem with the system, like a low battery. Other sounds you will only hear in an emergency. Getting to know your system sounds allows you to react quickly and appropriately.

Trouble Beeps and Trouble Messages

Trouble beeps are a series of five short beeps, once a minute.

When your system detects a problem, it lets you know by sounding trouble beeps from touchpads and sirens, and by trouble messages on touchpad displays.

Table 4 lists the causes of trouble beeps, the visual display you can expect to see, and possible solutions for the trouble condition.

Silencing Trouble Beeps

If possible, correct the situation which is causing the trouble beeps. If this is not possible, call for service. If the problem is not corrected, trouble beeps and messages start again 4 to 10 hours later.

To stop trouble beeps:

- Perform a system status check by pressing **[*]** on a touchpad,
- change the arming level.

The following table describes the conditions under which trouble beeps occur and when they begin. (These sounds are heard from interior sirens and touchpads if available.)

Q. *I can't arm my system.*

A. Try the following:

- If arming to Level 2—STAY or Level 3—AWAY, make sure all monitored perimeter doors and windows are closed.
- Press  for a system status and for clues to the problem.
- Call the installer.

Q. *I cannot bypass a sensor: my alphanumeric touchpad displays "INVALID" and my fixed English touchpad sounds a single, long beep.*

A. Possible explanations include:

- The sensor you're trying to bypass may not be active in the current arming level. For example, an interior motion detector will not be active in Level 2—STAY.
- Some sensors can be bypassed only in certain levels. For example, motion sensors in Level 3—AWAY.
- You may be trying to bypass a 24-hour sensor that cannot be bypassed, such as a smoke detector.

Q. *I can't arm my system to Level 3—AWAY.*

A. If a delay door is open while you're trying to arm the system to Level 3, the system will arm to Level 2 instead. Close the delay door, arm the system to Level 3, then exit through a delay door.

Table 1. Causes of Trouble Beeps

Touchpad Feedback After Pressing 	Trouble Condition
AC POWER FAILURE	The panel power transformer may be unplugged or there may be an AC power outage. If the transformer is plugged in, check the circuit breaker or fuse that controls that outlet. The backup battery will take over, but if AC power is not restored within 15 minutes, the system will alert you and the central monitoring station (if your system is monitored). It reports again when power is restored.
LOW BATT	The power in the emergency backup battery is low and must be recharged or replaced. If AC power is out, the security system may shut down once the battery is below the operating level. When AC power is restored, the panel will recharge the battery. If the trouble condition exists more than 24 hours after AC power is restored, call your security dealer for service.
SENSOR SUPERVISORY	There is a problem with how the sensor is communicating with the panel. <ol style="list-style-type: none"> 1. Test the sensor in Test Mode as described on page 15. 2. If the sensor does not test OK, call your security dealer for service.
SENSOR TROUBLE	A sensor may have an internal problem or a fire/smoke sensor may not have properly reset after activation, or the sensing chamber may be dirty or partially obstructed. <ol style="list-style-type: none"> 1. Test the sensor in Test Mode as described on page 15. 2. If testing the sensor does not clear the trouble condition, call your security dealer for service.
SENSOR XX LOW BATTERY	A sensor has a low battery. <ol style="list-style-type: none"> 1. Disarm the system. 2. Remove the sensor cover. If the battery is an Alkaline AAA, change the battery. If the battery is any other type, call your security dealer for service.
SENSOR XX TAMPER	A sensor cover is off or open. Secure the cover and trip the sensor to clear the tamper condition.
PHONE FAILURE TROUBLE	The system can't communicate with the central monitoring station. The system tries to report to the central station three times before indicating Phone Failure Trouble, then makes five more reporting attempts. <ol style="list-style-type: none"> 1. Make sure the panel is connected to the special phone jack installed by your security dealer. 2. Disconnect the panel from the special phone jack and check phones for dial tone. <p>If you hear a dial tone, call your security dealer for service.</p> <p>If you don't hear dial from any phones, telephone service in your area may be out.</p> <p>Phone Failure Trouble takes precedence over other system problems, so you must clear the Phone Failure message (by disarming the panel) before you're able to see other system messages.</p>
RECEIVER INTERFERENCE or RECEIVER FAILURE	There is a receiver failure or receiver interference problem. Call your security dealer for service.
MEMORY FAILURE or all text is lit on a fixed English touchpad	There is a system memory failure. Call your security dealer for service.

APPENDIX A: USER SHEETS

It contains specific information about the setup of your system.
The User Sheets should be completed by the installer and the user.

ACCOUNT NUMBER

My central station account number is:

SYSTEM SENSORS

Record the sensor number and name in the table below.
Indicate whether it is a:
hardwired sensor (HW), wireless sensor (WL), or touchpad (TP).

No.	Sensor Name	HW / WL / TP
01		
02		
03		
04		
05		
06		
07		
08		
09		
10		
11		
12		
13		
14		
15		
16		
17		
18		
19		
20		
21		
22		
23		
24		

USER CODES

The tables below provide space for you to record user codes and the attributes of each. If you would like the Latchkey attribute changed for any code, contact your dealer.

- B* User can bypass sensors.
- L* Users can send Latchkey pages.
- S* User can perform system tests.

Defaults are indicated by }

	B	L	S	Code
System Master	}	N/A	}	(Default: 1234)
00				
01				
02				
03				
04				
05				
06				
07				
08				
09				
10				
11				
12				
13				
14				
15				

TOUCHPAD INFORMATION

Status beeps and Key beeps are programmable by the installer.
The Silent Arming feature is user-programmable.
Protest beeps upon bypassing will always sound.

Location of TP	Status Beeps	Key Beeps
	On/Off	On/Off
	On/Off	On/Off
	On/Off	On/Off
	On/Off	On/Off
	On/Off	On/Off
	On/Off	On/Off
	On/Off	On/Off
	On/Off	On/Off
	On/Off	On/Off
	On/Off	On/Off
	On/Off	On/Off
	On/Off	On/Off
	On/Off	On/Off
	On/Off	On/Off

Is Touchpad Tamper feature on?

- ◆ Yes. If, when the system asks for a code, more than 40 touchpad keys are pressed in rapid succession and those keystrokes are not part of a valid access code, a siren will sound.
- ◆ No. Multiple keypresses that are not part of a valid access code will not send an alarm.

There are _____ keychain touchpads in use in the system.

Keychain Touchpad 1

Press the Lock key to:

- Increase the arming level.
- Arm the system to Level 3 with no Exit or Entry delay.

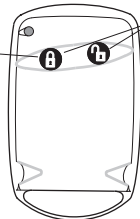

Press both at one time to:

- Create a Police panic alarm.
- Create an Auxiliary panic alarm.
- Other: _____

Keychain Touchpad 2

Press the Lock key to:

- Increase the arming level.
- Arm the system to Level 3 with no Exit or Entry delay.

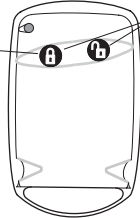

Press both at one time to:

- Create a Police panic alarm.
- Create an Auxiliary panic alarm.
- Other: _____

Keychain Touchpad 3

Press the Lock key to:

- Increase the arming level.
- Arm the system to Level 3 with no Exit or Entry delay.

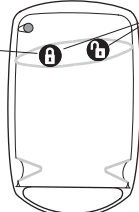

Press both at one time to:

- Create a Police panic alarm.
- Create an Auxiliary panic alarm.
- Other: _____

Keychain Touchpad 4

Press the Lock key to:

- Increase the arming level.
- Arm the system to Level 3 with no Exit or Entry delay.

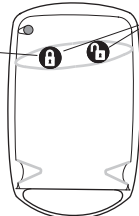

Press both at one time to:

- Create a Police panic alarm.
- Create an Auxiliary panic alarm.
- Other: _____

ACCIDENTAL SMOKE AND FIRE ALARMS

To silence the alarms and reset the sensor:

- Press **[1]** + Code, once to silence the alarm.
- Press **[1]** + Code, twice to reset the smoke alarm.

Smoke and fire panic alarms cannot be cancelled and are always reported to the central station.

If, after disarming the system once, the system still thinks a sensor is open, disarm the system again.

In the event of an accidental smoke or fire alarm, follow these dealer instructions:

DIALER ABORT

Is the Dialer Abort feature enabled?

- ◆ Yes. I have _____ seconds to cancel an accidental intrusion or auxiliary alarm before it is reported to the central station.
- ◆ No. All alarms are reported to the central station immediately.

ARMING INFORMATION

Delay Doors and Delay Time Settings

When the system is armed, enter and exit the premises only through designated delay doors.

The time allowed to enter the premises and disarm the system is the Entry Delay time.

The time allowed to leave the premises after arming the system is the Exit Delay time.

Door	Door Location	Entry Delay	Exit Delay
1		:	:
2		:	:
3		:	:
4		:	:
5		:	:

Feature	My system features include:
Quick Arm	<ul style="list-style-type: none"> ◆ Yes. Press the arming level desired. ◆ No. Enter arming level, then access code.
Quick Exit	<ul style="list-style-type: none"> ◆ Yes. Press [D] and exit your armed premises through a delay door within 2 minutes. ◆ No. I need to disarm my system in order to exit the premises.
Exit Extension	<ul style="list-style-type: none"> ◆ Yes. If I re-enter the armed premises during the Exit Delay time, the Exit Extension will begin. ◆ No. If I re-enter the armed premises during the Exit Delay time, it will continue to count down and I must disarm the system.
Keyswitch Arming	<ul style="list-style-type: none"> ◆ Yes. I can use a key to arm the system. The switch is located: _____ _____ ◆ No.
Auto STAY Arming	<ul style="list-style-type: none"> ◆ Yes. If, after arming to Level 3—AWAY, I don't exit through a designated delay door, the system will arm to Level 2—STAY. ◆ No. If, after arming to Level 3—AWAY, I don't exit through a designated delay door, the system will continue to arm to Level 3—AWAY. And, if my system contains motion detectors, movement may cause an alarm.

PAGING

For what events will the central station or pagers be notified?

Reporting Features	CS 1	CS 2	Pagers		
			1	2	3
High Level Reports					
Low Level Reports					
Opening/Closing Reports					
Latchkey Reports	N/A	N/A			

Is the Streamlining feature enabled?

- ◆ Yes. When the system pages me, the message will not include the central station account number. According to my pager provider, the central station account number will appear as:

- ◆ No. All pages from my system will include the account number.

IF THE POWER GOES OUT

Your system has a backup battery that keeps your system operational during a power failure. An optional feature allows your system to alert the central monitoring station if the power is off for more than 15 minutes. It reports again when power has been restored.

NO ACTIVITY TIME

My system uses the No Activity feature.

- ◆ Yes. If there is no activity in my system for ____ hours (1-42, default 24), the system will send a No Activity report to the Central Station.
- ◆ No. My system setup does not include this feature.

SYSTEM INFORMATION

System Information	Code
Factory code	
System number	
System level	

APPENDIX B: PLANNING FOR EMERGENCIES

Develop plans for a variety of emergency situations. Periodically discuss and rehearse emergency plans that include the following:

- Understand how to use your security system.
- Know the normal state of doors and windows; open, closed, or locked.
- Use a different escape route if closed doors feel hot to the touch.
- Emphasize that everyone should escape as quickly as possible. Do not stop to gather any belongings.
- Crawl and hold your breath as much as possible to help reduce smoke inhalation during your escape.
- Meet at a designated outdoor location.
- Emphasize that no one should return to the premises if there is a fire.
- Notify fire department from a neighbor's phone.

WARNING! If you arrive at the premises and hear sirens, do not attempt to enter the building. Call for emergency assistance from a neighbor's phone.

FLOOR PLAN EXAMPLE

The figure on this page is an example of a multilevel floor plan. Use it as a guide and draw your floor plan on the next page.

YOUR FLOOR PLAN

Use the following guidelines when drawing your floor plan:

- ◆ Show all building levels.
- ◆ Show exits from each room (two exits per room are recommended).
- ◆ Show the location of all security system components.
- ◆ Show the locations of any fire extinguishers.

Alarm System Limitations

Not even the most advanced alarm system can guarantee protection against burglary, fire, or environmental emergencies. All alarm systems are subject to possible compromise or failure-to-warn, for a variety of reasons including:

- If sirens are not placed within range of persons sleeping, in remote areas of the premises, or if they are placed behind doors or other obstacles.
- If intruders gain access through unprotected entry points or areas where sensors are bypassed.
- If intruders have the technical means of bypassing, jamming, or disconnecting any or all parts of the system.
- If power to sensors is disconnected or inadequate.
- If freeze, flood, or any environmental sensors are not located in areas where the specific condition can be detected.
- If smoke does not reach a smoke sensor. For example, smoke sensors cannot detect smoke in chimneys, walls, roofs, or smoke blocked by a closed door. Sensors may not detect smoke on building levels different from their installed location. Sensors may not warn in time when fires are caused by smoking in bed, explosions, improper storage of flammables, overloaded electrical circuits, or other hazardous conditions.

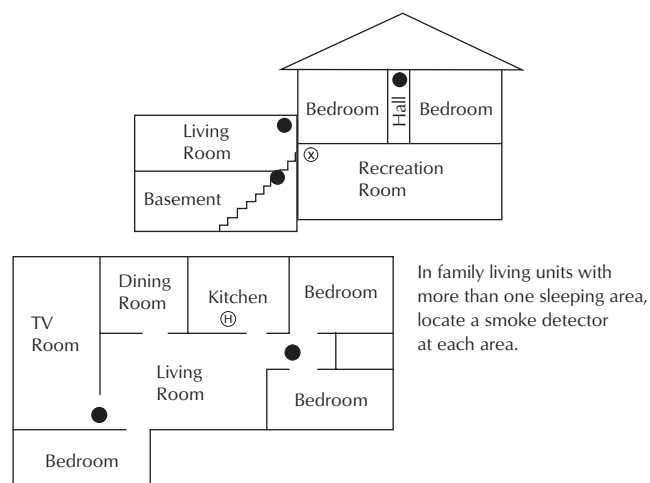
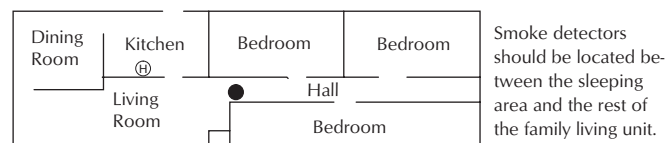
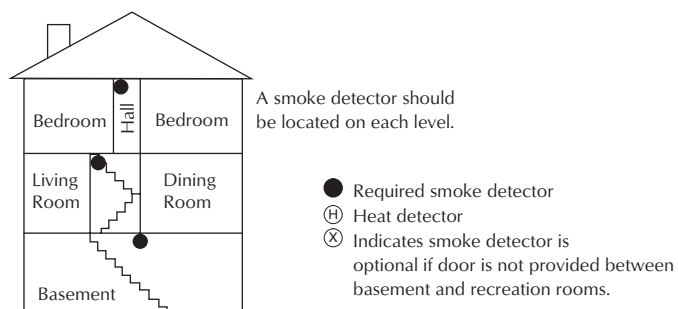

NOTE: Ceiling-mounted smoke detectors should be located in the center of the room or hall, or not less than 4 inches from the wall. When the detector is mounted on the wall, the top of the detector should be 4 to 12 inches from the ceiling.

NOTE: Do not install smoke detectors where normal ambient temperatures are above 100°F or below 40°F. Also, do not locate detectors in front of AC/Heat registers or other locations where normal air circulation will keep smoke from entering the detector.

NOTE: Additional information on household fire warning is available at nominal cost from: The National Fire Protection Association, Batterymarch Park, Quincy, MA 02269. Request Standard No. NFPA74.

- If telephone lines are out of service. Telephone lines are also vulnerable to compromise by any of several means.

Inadequate maintenance is the most common cause of alarm failure. Therefore, test your system once each week to verify sensors, sirens, and phone communications are all working correctly.

Note: Although having an alarm system can make you eligible for reduced insurance premiums, the system is no substitute for insurance.

Warning: Security systems and devices cannot compensate you for life or property losses.

If Your System Needs Service

If you have any questions about your security system or if it ever needs servicing, please contact your security dealer.

Company Name _____

Address _____

City _____ State _____ Zip _____

Phone Number (____) _____

Contact Name _____

Floor Plan of Your Home or Business

A large, empty rectangular box with a thin black border, intended for drawing a floor plan of a home or business. The box occupies most of the lower half of the page.

APPENDIX C: PROGRAMMING YOUR SYSTEM

You can program the following items on your system:

- System time and date
- User codes
- Downloading feature
- Silent Arming feature
- Brightness of touchpads
- Chime feature

TWO METHODS TO PROGRAM YOUR SYSTEM

There are 2 methods for programming your system:

- Programming menus—Offers visual text cues from your touchpad
- Programming shortcuts—Allows you to type in a sequence of numbers for a specific programming task.

Either method requires a valid System Master code. You cannot program the system using a regular user code.

Using Programming Menus

The programming menus are arranged much like a computer software program: menus containing multiple options.

To navigate through the menus:

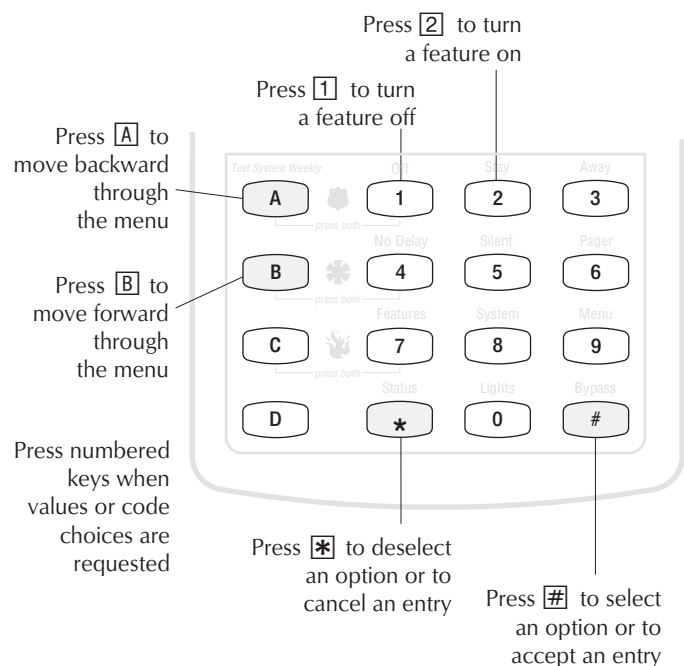

Examples of Programming Using Menus

Here are two examples of programming using system menus. The examples describe each step involved in programming a user code and in erasing a user code from a fixed English touchpad.

To change or assign a user access code:

1. Enter the programming menus by pressing [9] + System Master Code.
2. Press [B] until the touchpad displays “USER CODES,” then press [#].
3. Press [B] until the touchpad displays the type of code you wish to change (Regular User codes or System Master code), then press [#].
For example, if you want to change a Regular User code, press [#] when the touchpad displays “REG CODES.”
4. Press [B] until the touchpad displays the user code you wish to change, then press [#].
For example, if you want to change Regular User code 2, press [#] when the touchpad displays “REG CODE 02.”
5. Enter the new code and press [#].
6. Press [B]. “DIRECT BYPASSING” (or “BYPASS”) appears:
 - Press [1] + [#] to turn the option *off* for this user code.
 - Press [2] + [#] to turn the option *on* for this user code.
7. Press [B]. “SYSTEM TESTS” (or “TESTS”) appears:
 - Press [1] + [#] to turn the option *off* for this user code.
 - Press [2] + [#] to turn the option *on* for this user code.
8. Press [*] + [B] to move to the next user code, or [*] + [4] + [#] to exit the programming menus.

Note: The system will not accept the same code for two different users.

To erase a user code:

1. Enter the programming menus by pressing [9] + System Master Code.
2. Press [B] until the touchpad displays “USER CODES,” then press [#].
3. The touchpad displays “REG CODES.” Press [#]. (You cannot delete the System Master code.)
4. Press [B] until the touchpad displays the user code you wish to erase, then press [#].
For example, if you want to change User code 4, press [#] when the touchpad displays “REG CODE 04,” or “USER 04.”
5. Enter the System Master code you used in Step 1 and press [#]. The deleted code appears as “REG 01 —,” or “USER 01 —* * * *,” for example.
6. Press [*] + [B] to move to the next user code, or [*] + [4] + [#] to exit the programming menus.

At a touchpad, press **[9]**

System displays:

Enter code

Enter the System Master code.

System displays briefly:

SYSTEM MENU

Then, system displays:

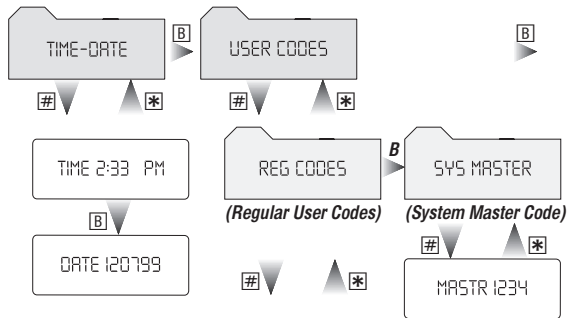

Press **[B]** to move forward in the menu.

Press **[A]** to move backward in the menu.

Press **[*]** to back out of the menu.

Press **[#]** to enter the menu.

Press **[1]** to turn a feature off.

Press **[2]** to turn a feature on.

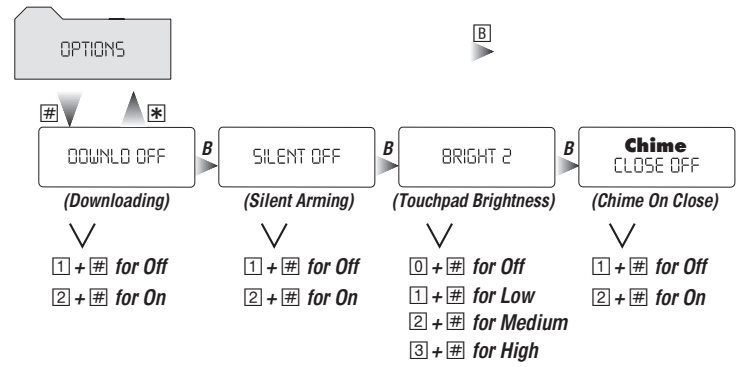

Press **[B]** to return to the start of the Programming Menu.

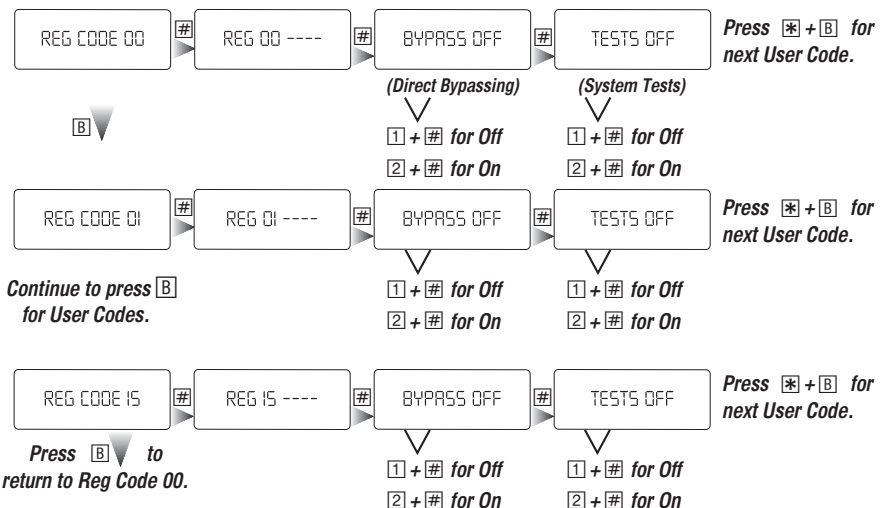
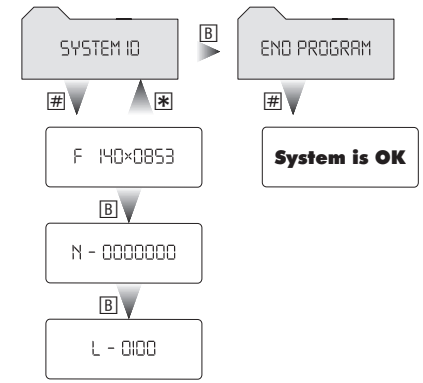

Continue to press **[B]** for User Codes.

Press **[B]** to return to Reg Code 00.

Direct Bypassing

A user attribute that, when on, allows the user to bypass sensors directly by pressing: **[#] + code + sensor number**

System Tests

A user attribute that, when on, allows the user to enter test mode by pressing:
[8] + code + [2] (Phone Test)
[8] + code + [3] (Sensor Test)

Downloading

When feature is on: Allows dealer to make changes to the system from off-site.

Silent Arming

When feature is on: Status beeps while arming will be silent.

Chime On Close

When feature is on and Chime is turned on (**[7] + [1]**):
2 beeps sound when a protected door or window is opened.
1 beep sounds when the door or window is closed again.

Using Programming Shortcuts

A programming shortcut is a number that gets you to a particular spot in the programming menus. A series of shortcut numbers takes you directly to the feature or code you want to change.

The table below lists:

1. How to enter the programming menus.
2. User programming tasks.
3. The sequence of keypresses to take you to the task.
4. Specific information to enter for the task.
5. How to accept an entry.
6. How to exit the programming menus.

- | | | | | | |
|-----------------------------|-----------------------------|---|---------------------------|-------------------|----------------------------|
| 1. Enter programming menus: | 2. Choose programming task. | 3. Enter [*] + [*] , then key sequence. | 4. Enter value or choice. | 5. Secure choice. | 6. Exit programming menus. |
|-----------------------------|-----------------------------|---|---------------------------|-------------------|----------------------------|

[9] + Master Code	Set system time	0 0	Time in 24-hour format (<i>Enter 4 digits</i>)	#	[*] + [4] + [#]
	Set system date	0 1	Enter 6-digit date in mm/dd/yy format		
	Change User code 00	1 0 0 0 0	4-digit code		
	Direct Bypassing for User 00	1 0 0 0 1	[1] (Off) or [2] (On)		
	System Tests for User 00	1 0 0 0 2			
	Change User code 01	1 0 0 1 0	4-digit code		
	Direct Bypassing for User 01	1 0 0 1 1	[1] (Off) or [2] (On)		
	System Tests for User 01	1 0 0 1 2			
	Change User code 02	1 0 0 2 0	4-digit code		
	Direct Bypassing for User 02	1 0 0 2 1	[1] (Off) or [2] (On)		
	System Tests for User 02	1 0 0 2 2			
	Change User code 03	1 0 0 3 0	4-digit code		
	Direct Bypassing for User 03	1 0 0 3 1	[1] (Off) or [2] (On)		
	System Tests for User 03	1 0 0 3 2			
	Change User code 04	1 0 0 4 0	4-digit code		
	Direct Bypassing for User 04	1 0 0 4 1	[1] (Off) or [2] (On)		
	System Tests for User 04	1 0 0 4 2			
	Change User code 05	1 0 0 5 0	4-digit code		
	Direct Bypassing for User 05	1 0 0 5 1	[1] (Off) or [2] (On)		
	System Tests for User 05	1 0 0 5 2			
	Change User code 06	1 0 0 6 0	4-digit code		
	Direct Bypassing for User 06	1 0 0 6 1	[1] (Off) or [2] (On)		
	System Tests for User 06	1 0 0 6 2			
	Change User code 07	1 0 0 7 0	4-digit code		
	Direct Bypassing for User 07	1 0 0 7 1	[1] (Off) or [2] (On)		
	System Tests for User 07	1 0 0 7 2			

1. Enter programming menus: 2. Choose programming task. 3. Enter $\boxed{*}$ + $\boxed{*}$, then key sequence. 4. Enter value or choice. 5. Secure choice. 6. Exit programming menus.

$\boxed{9}$ + Master Code	Change User code 08	1 0 0 8 0	4-digit code	$\boxed{\#}$	$\boxed{*}$ + $\boxed{4}$ + $\boxed{\#}$
	Direct Bypassing for User 08	1 0 0 8 1	$\boxed{1}$ (Off) or $\boxed{2}$ (On)		
	System Tests for User 08	1 0 0 8 2			
	Change User code 09	1 0 0 9 0	4-digit code		
	Direct Bypassing for User 09	1 0 0 9 1	$\boxed{1}$ (Off) or $\boxed{2}$ (On)		
	System Tests for User 09	1 0 0 9 2			
	Change User code 10	1 0 1 0 0	4-digit code		
	Direct Bypassing for User 10	1 0 1 0 1	$\boxed{1}$ (Off) or $\boxed{2}$ (On)		
	System Tests for User 10	1 0 1 0 2			
	Change User code 11	1 0 1 1 0	4-digit code		
	Direct Bypassing for User 11	1 0 1 1 1	$\boxed{1}$ (Off) or $\boxed{2}$ (On)		
	System Tests for User 11	1 0 1 1 2			
	Change User code 12	1 0 1 2 0	4-digit code		
	Direct Bypassing for User 12	1 0 1 2 1	$\boxed{1}$ (Off) or $\boxed{2}$ (On)		
	System Tests for User 12	1 0 1 2 2			
	Change User code 13	1 0 1 3 0	4-digit code		
	Direct Bypassing for User 13	1 0 1 3 1	$\boxed{1}$ (Off) or $\boxed{2}$ (On)		
	System Tests for User 13	1 0 1 3 2			
	Change User code 14	1 0 1 4 0	4-digit code		
	Direct Bypassing for User 14	1 0 1 4 1	$\boxed{1}$ (Off) or $\boxed{2}$ (On)		
	System Tests for User 14	1 0 1 4 2			
	Change User code 15	1 0 1 5 0	4-digit code		
	Direct Bypassing for User 15	1 0 1 5 1	$\boxed{1}$ (Off) or $\boxed{2}$ (On)		
	System Tests for User 15	1 0 1 5 2			
	Change System Master Code	1 1 0	4-digit code		
	Downloading	2 0	$\boxed{1}$ (Off) or $\boxed{2}$ (On)		
	Silent Arming	2 1	$\boxed{1}$ (Off) or $\boxed{2}$ (On)		
	Touchpad Brightness	2 2	$\boxed{0}$ for Off $\boxed{1}$ for Low $\boxed{2}$ for Medium $\boxed{3}$ for High		
	Chime on Close	2 5	$\boxed{1}$ (Off) or $\boxed{2}$ (On)		
	Factory Code	3 0			
System Number	3 1				
System Level	3 2				

Notes:

Notes:

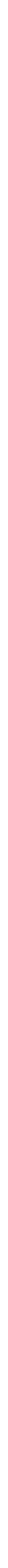

Notes:

FCC Notices

This equipment has been tested and found to comply with the limits for a class B digital device, pursuant to part 15 of the FCC rules. These limits are designed to provide reasonable protection against harmful interference in a residential installation. This equipment generates, uses, and can radiate radio frequency energy and, if not installed and used in accordance with the instructions, may cause harmful interference to radio communications. However, there is no guarantee that interference will not occur in a particular installation. If this equipment does cause harmful interference to radio or television reception, which can be determined by turning the equipment off and on, the user is encouraged to try to correct the interference by one or more of the following measures:

- Install a quality radio or television outdoor antenna if the indoor antenna is not adequate.
- Reorient or relocate the panel.
- Move the panel away from the affected equipment.
- Move the panel away from any wire runs to the affected equipment.
- Connect the affected equipment and the panel to separate outlets, on different branch circuits.
- Consult the dealer or an experienced radio/TV technician for help.
- Send for the FCC booklet How to Identify and Resolve Radio-TV Interference Problems, available from the U.S. Government Printing Office, Washington, D.C. 20402. Stock Number: 004-000-00345-4.

Changes or modifications not expressly approved by Interactive Technologies, Inc. can void the user's authority to operate the equipment.

This equipment complies with part 68 of the FCC rules. On the FCC label affixed to this equipment is the FCC Registration Number and Ringer Equivalence Number (REN) for this equipment. If requested, provide this information to your telephone company.

The REN is used to calculate the maximum number of devices your telephone line will support with ringing service. In most areas the sum of all device RENs should not exceed 5.0. Contact your local telephone company to determine the maximum REN for your calling area.

If your telephone equipment causes harm to the telephone network, your telephone company may temporarily disconnect your service. If possible, you will be notified in advance. When advance notice is not practical, you will be notified as soon as possible. You will also be advised of your right to file a complaint with the FCC.

Your telephone company may make changes in its facilities, equipment, operations, or procedures that could affect the proper operation of your equipment. You will be given advanced notice in order to maintain uninterrupted service. The telephone company may ask you to disconnect this equipment from the network until the problem has been corrected or until you are sure that the equipment is not malfunctioning. This equipment may not be used on coin service provided by the telephone company. Connection to party lines is subject to state tariffs.

Declaration of Conformity (DoC)

Interactive Technologies, Inc. declares that the ITI model no. 60-792-95R is in conformity with Part 15 of the FCC Rules. Operation of this product is subject to the following two conditions: (1) This device may not cause harmful interference, and (2) this device must accept any interference received, including interference that may cause undesired operation.

Industry Canada Warnings

Notice:

The Industry Canada Label identifies certified equipment. This certification means that the equipment meets telecommunications network protective, operational, and safety requirements as prescribed in the appropriate Terminal Equipment Technical Requirement document(s). The Department does not guarantee the equipment will operate to the user's satisfaction.

Before installing this equipment, users should ensure that it is permissible to be connected to the facilities of the local telecommunications company. The equipment must also be installed using an acceptable method of connection. The customer should be aware that compliance with the above conditions may not prevent degradation of service in some situations.

Repairs to certified equipment should be coordinated by a representative designated by the supplier. Any repairs or alterations made by the user to this equipment, or equipment malfunctions, may give the telecommunications company cause to request the user to disconnect the equipment.

Users should ensure for their own protection that the electrical ground connections of the power utility, telephone lines, and internal metallic water pipe system, if present, are connected together. This precaution may be particularly important in rural areas.

Caution: Users should not attempt to make such connections themselves, but should contact the appropriate electric inspection authority, or electrician, as appropriate.

Notice: The Ringer Equivalence Number (REN) assigned to each terminal device provides an indication of the maximum number of terminals allowed to be connected to a telephone interface. The termination on an interface may consist of any combination of devices subject only to the requirement that the sum of the Ringer Equivalence Number of all the devices does not exceed 5.

AVIS D'INDUSTRIE CANADA

AVIS:

L'étiquette d'Industrie Canada identifie le matériel homologué. Cette étiquette certifie que le matériel est conforme aux normes de protection, d'exploitation et de sécurité des réseaux de télécommunications, comme le prescrivent les documents concernant les exigences techniques relatives au matériel terminal. Le Ministère n'assure toutefois pas que le matériel fonctionnera à la satisfaction de l'utilisateur.

Avant d'installer ce matériel, l'utilisateur doit s'assurer qu'il est permis de le raccorder aux installations de l'entreprise locale de télécommunication. Le matériel doit également être installé en suivant une méthode acceptée de raccordement. L'abonné ne doit pas oublier qu'il est possible que la conformité aux conditions énoncées ci-dessus n'empêche pas la dégradation du service dans certaines situations.

Les réparations de matériel homologué doivent être coordonnées par un représentant désigné par le fournisseur. L'entreprise de télécommunications peut demander à l'utilisateur de débrancher un appareil à la suite de réparations ou de modifications effectuées par l'utilisateur ou à cause de mauvais fonctionnement.

Pour sa propre protection, l'utilisateur doit s'assurer que tous les fils de mise à la terre de la source d'énergie électrique, des lignes téléphoniques et des canalisations d'eau métalliques, s'il y en a, sont raccordés ensemble. Cette précaution est particulièrement importante dans les régions rurales.

Avertissement: L'utilisateur ne doit pas tenter de faire ces raccordements lui-même; il doit avoir recours à un service d'inspection des installations électriques, ou à un électricien, selon le cas.

AVIS:

L'indice d'équivalence de la sonnerie (IES) assigné à chaque dispositif terminal indique le nombre maximal de terminaux qui peuvent être raccordés à une interface. La terminaison d'une interface téléphonique peut consister en une combinaison de quelques dispositifs, à la seule condition que la somme d'indices d'équivalence de la sonnerie de tous les dispositifs n'excède pas 5.

Trademarks

ITI is a registered trademark of Interactive Technologies, Inc. Concord, SuperBus, SnapCard, and ToolBox are trademarks of Interactive Technologies, Inc. X-10 is a registered trademark of X-10 (USA), Inc.

This manual may refer to products that are announced but are not yet available.

- A**
- AC Power Fail Reports 12
 - access codes 10, 25, 26
 - accidental alarms 6, 19
 - account number in page 13
 - alarms, cancelling 6
 - arming levels 4
 - arming the system 7, 8
 - Auto Phone Test Reports 12
 - Auto STAY Arming feature 8
 - auxiliary alarm 2
 - Auxiliary panic alarm 9, 10, 12
- B**
- Battery Backup feature 20
 - Bus Failure Reports 12
 - Bypass Sensor Reports 12
 - bypassing sensors 8
- C**
- cancelling alarms 6
 - Chime feature 4, 6, 12
 - Chime On Close feature 26
 - Chime-On-Close feature 6
 - Closing Reports 12, 20
 - communication test 16
 - CPU Back in Service Reports 12
 - CPU Low Battery Reports 12
- D**
- date, setting on the system 11, 25
 - Dealer code 13
 - Delay door(s) 20
 - Dialer Abort feature 6, 19, 20
 - Direct Bypassing attribute 8
 - disarming the system 4
 - door/window sensors 15, 18
 - Download feature 14, 26
 - Duress Alarm Reports 12
- E**
- emergency planning 21
 - Entry Delay 4, 7, 20
 - erasing user codes 10
 - Event Buffer Full Reports 12
 - event code 13
 - Exit Delay 4, 6, 7, 20
 - Exit Extension feature 7, 20
 - extended Exit Delay 7
- F**
- factory code 14, 20, 26
 - false alarms 15, 19
 - fire alarms 2
 - Fire panic alarm 8, 9
 - Fire Panic Reports 12
 - fixed English touchpad 12
 - floor plan 21
 - Force Armed Reports 12
 - Full System Status 9
- G**
- glass guard sensors 16
- H**
- High Level Reports 12, 20
 - Hi-Tech Wireless Handheld touchpads 3
- I**
- Installer code 13
- K**
- Key Beeps feature 4, 19
 - keychain touchpads 5, 15, 19
 - keyswitch arming 4, 13, 20
- L**
- Latchkey Paging Reports 12
 - Latchkey-designated users codes 14
 - Level 1-OFF 2, 4, 5
 - Level 2-STAY 2, 5
 - Level 3-AWAY 2, 5
 - Low Battery Reports 12
 - Low Level Reports 12, 20
- M**
- Master code 10, 26
 - motion detectors 15
- N**
- No Activity Alarm Reports 12
 - No Activity feature 14, 20
 - No Delay feature 2, 7
- O**
- opening doors or windows 8
 - Opening Reports 12, 20
- P**
- pager codes 13
 - paggers 12, 20
 - panic alarms 9
 - panic buttons 15
 - Phone Failure Reports 12
 - Phone Failure Trouble 17
 - phone test 16
 - Phone Test Reports 12
 - police alarm 2
 - Police panic alarm 8, 9
 - Police Panic Reports 12
 - preventing accidental alarms 6
 - programming menus 10
 - Protest beeps 4
- Q**
- Quick Arming feature 5, 13, 20
 - Quick Exit feature 5, 20
- R**
- Rate-of-Rise heat detectors 15
 - Receiver Failure Reports 12
 - Receiver Jam Reports 12
 - remote phone access 9
 - resetting smoke detectors 19
 - Restoral Reports 12
- S**
- Sensor Alarm Reports 12
 - sensor number in page 13
 - Sensor Restoral Reports 12
 - Sensor Supervisory Reports 12
 - Sensor Tamper Reports 12
 - sensor test 4, 15
 - shock sensors 15
 - Short System Status 9
 - Silent Arming feature 11, 19, 26
 - siren test 16
 - siren time-out 10
 - smoke detectors 4, 15, 19
 - Status beeps 4, 19
 - Streamline feature 13
 - supervised wireless siren 16
 - System Alarm Sounds 9
 - system level 14, 20, 26
 - System Master code 10, 13, 26
 - system number 20, 26
 - System Status 9
- T**
- System Tests user code attribute 11
 - system version 14
 - tamper prevention 11
 - Tamper Reports 12
 - test mode 15, 16
 - testing the system 15
 - time, setting on the system 11, 25
 - Touchpad Low Battery Reports 12
 - Touchpad Supervisory Reports 12
 - Touchpad Tamper feature 11, 19
 - Touchpad Tamper Reports 12
 - touchpads 3, 15, 19, 26
 - trouble beeps 4, 12, 15
 - trouble conditions 9
 - Trouble Reports 12
 - troubleshooting 15
- U**
- user code 13
 - user codes 10, 13, 15, 18, 25
- V**
- verifying alarm sounds 16
 - volume of touchpad 12
- W**
- window sensors 15, 18



INTERACTIVE TECHNOLOGIES, INC.

2266 SECOND STREET NORTH

NORTH SAINT PAUL, MN 55109

W I R E L E S S

Security

Automation

Access Control

©1999 Interactive Technologies, Inc.

A
AC Power Fail Reports 12
access codes 10, 25, 26
accidental alarms 6, 19
account number in page 13
alarms, cancelling 6
arming levels 4
arming the system 7, 8
Auto Phone Test Reports 12
Auto STAY Arming feature 8
auxiliary alarm 2
Auxiliary panic alarm 9, 10, 12

B
Battery Backup feature 20
Bus Failure Reports 12
Bypass Sensor Reports 12
bypassing sensors 8

C
cancelling alarms 6
Chime feature 4, 6, 12
Chime On Close feature 26
Chime-On-Close feature 6
Closing Reports 12, 20
communication test 16
CPU Back in Service Reports 12
CPU Low Battery Reports 12

D
date, setting on the system 11, 25
Dealer code 13
Delay door(s) 20
Dialer Abort feature 6, 19, 20
Direct Bypassing attribute 8
disarming the system 4
door/window sensors 15, 18
Download feature 14, 26
Duress Alarm Reports 12

E
emergency planning 21
Entry Delay 4, 7, 20
erasing user codes 10
Event Buffer Full Reports 12
event code 13
Exit Delay 4, 6, 7, 20

Exit Extension feature 7, 20
extended Exit Delay 7

F
factory code 14, 20, 26
false alarms 15, 19
fire alarms 2
Fire panic alarm 8, 9
Fire Panic Reports 12
fixed English touchpad 12
floor plan 21
Force Armed Reports 12
Full System Status 9

G
glass guard sensors 16

H
High Level Reports 12, 20
Hi-Tech Wireless Handheld touchpads 3

I
Installer code 13

K
Key Beeps feature 4, 19
keychain touchpads 5, 15, 19
keyswitch arming 4, 13, 20

L
Latchkey Paging Reports 12
Latchkey-designated users codes 14
Level 1-OFF 2, 4, 5
Level 2-STAY 2, 5
Level 3-AWAY 2, 5
Low Battery Reports 12
Low Level Reports 12, 20

M
Master code 10, 26
motion detectors 15

N
No Activity Alarm Reports 12
No Activity feature 14, 20
No Delay feature 2, 7

O
opening doors or windows 8
Opening Reports 12, 20

P
pager codes 13
pagers 12, 20
panic alarms 9
panic buttons 15
Phone Failure Reports 12
Phone Failure Trouble 17
phone test 16
Phone Test Reports 12
police alarm 2
Police panic alarm 8, 9
Police Panic Reports 12
preventing accidental alarms 6
programming menus 10
Protest beeps 4

Q
Quick Arming feature 5, 13, 20
Quick Exit feature 5, 20

R
Rate-of-Rise heat detectors 15
Receiver Failure Reports 12
Receiver Jam Reports 12
remote phone access 9
resetting smoke detectors 19
Restoral Reports 12

S
Sensor Alarm Reports 12
sensor number in page 13
Sensor Restoral Reports 12
Sensor Supervisory Reports 12
Sensor Tamper Reports 12
sensor test 4, 15
shock sensors 15
Short System Status 9
Silent Arming feature 11, 19, 26
siren test 16
siren time-out 10

smoke detectors 4, 15, 19
Status beeps 4, 19
Streamline feature 13
supervised wireless siren 16
System Alarm Sounds 9
system level 14, 20, 26
System Master code 10, 13, 26
system number 20, 26
System Status 9
System Tests user code attribute 11
system version 14

T
tamper prevention 11
Tamper Reports 12
test mode 15, 16
testing the system 15
time, setting on the system 11, 25
Touchpad Low Battery Reports 12
Touchpad Supervisory Reports 12
Touchpad Tamper feature 11, 19
Touchpad Tamper Reports 12
touchpads 3, 15, 19, 26
trouble beeps 4, 12, 15
trouble conditions 9
Trouble Reports 12
troubleshooting 15

U
user code 13
user codes 10, 13, 15, 18, 25

V
verifying alarm sounds 16
volume of touchpad 12

W
window sensors 15, 18



INTERACTIVE TECHNOLOGIES, INC.
2266 SECOND STREET NORTH
NORTH SAINT PAUL, MN 55109

W I R E L E S S

Security
Automation
Access Control