

Operation Instruction

DIGITAL VIDEO RECORDER

D12LX (8-Channel + 4 IP)

D20LX (16-Channel + 4 IP)



Speco Technologies is constantly developing product improvements
We reserve the right to modify product design and specifications without notice and without incurring any obligation

Speco Technologies 200 New highway, Arnityville, NY 11701 1-800-645-5516 www.specotech.com



WARNING

RISK OF ELECTRIC SHOCK
DO NOT OPEN



WARNING: TO REDUCE THE RISK OF ELECTRIC SHOCK,
DO NOT REMOVE COVER (OR BACK).
NO USER-SERVICEABLE PARTS INSIDE.
REFER SERVICING TO QUALIFIED
SERVICE PERSONNEL.



The lightning flash with arrowhead symbol, within an equilateral triangle, is intended to alert the user to the presence of uninsulated "dangerous voltage" within the product's enclosure that may be of sufficient magnitude to constitute a risk of electric shock.



The exclamation point within an equilateral triangle is intended to alert the user to the presence of important operating and maintenance (servicing) instructions in the literature accompanying the appliance.

COMPLIANCE NOTICE OF FCC:

THIS EQUIPMENT HAS BEEN TESTED AND FOUND TO COMPLY WITH THE LIMITS FOR A CLASS A DIGITAL DEVICE, PURSUANT TO PART 15 OF THE FCC RULES. THESE LIMITS ARE DESIGNED TO PROVIDE REASONABLE PROTECTION AGAINST HARMFUL INTERFERENCE WHEN THE EQUIPMENT IS OPERATED IN A COMMERCIAL ENVIRONMENT. THIS EQUIPMENT GENERATES, USES, AND CAN RADIATE RADIO FREQUENCY ENERGY AND IF NOT INSTALLED AND USED IN ACCORDANCE WITH THE INSTRUCTION MANUAL, MAY CAUSE HARMFUL INTERFERENCE TO RADIO COMMUNICATIONS. OPERATION OF THIS EQUIPMENT IN A RESIDENTIAL AREA IS LIKELY TO CAUSE HARMFUL INTERFERENCE, IN WHICH CASE USERS WILL BE REQUIRED TO CORRECT THE INTERFERENCE AT THEIR OWN EXPENSE.

WARNING: CHANGES OR MODIFICATIONS NOT EXPRESSLY APPROVED BY THE PARTY RESPONSIBLE FOR COMPLIANCE COULD VOID THE USER'S AUTHORITY TO OPERATE THE EQUIPMENT.

THIS CLASS OF DIGITAL APPARATUS MEETS ALL REQUIREMENTS OF THE CANADIAN INTERFERENCE-CAUSING EQUIPMENT REGULATIONS.

The information in this manual is believed to be accurate as of the date of publication. We are not responsible for any problems resulting from the use thereof. The information contained herein is subject to change without notice. Revisions or new editions to this publication may be issued to incorporate such changes.

The software included in this product contains some Open Sources. You may obtain the complete corresponding source code from us. See the Open Source Guide on the software CD (*OpenSourceGuide\OpenSourceGuide.pdf*) or as a printed document included along with the Operation Instruction.

Important Safeguards

1. Read Instructions
All the safety and operating instructions should be read before the appliance is operated.

2. Retain Instructions
The safety and operating instructions should be retained for future reference.

3. Cleaning
Unplug this equipment from the wall outlet before cleaning it. Do not use liquid aerosol cleaners. Use a damp soft cloth for cleaning.

4. Attachments
Never add any attachments and/or equipment without the approval of the manufacturer as such additions may result in the risk of fire, electric shock or other personal injury.

5. Water and/or Moisture
Do not use this equipment near water or in contact with water.

6. Ventilation
Place this equipment only in an upright position. This equipment has an open-frame Switching Mode Power Supply (SMPS), which can cause a fire or electric shock if anything is inserted through the ventilation holes on the side of the equipment.

7. Accessories
Do not place this equipment on an unstable cart, stand or table. The equipment may fall, causing serious injury to a child or adult, and serious damage to the equipment. Wall or shelf mounting should follow the manufacturer's instructions, and should use a mounting kit approved by the manufacturer.



This equipment and cart combination should be moved with care. Quick stops, excessive force, and uneven surfaces may cause the equipment and cart combination to overturn.

8. Power Sources
This equipment should be operated only from the type of power source indicated on the marking label. If you are not sure of the type of power, please consult your equipment dealer or local power company.

9. Power Cords
Operator or installer must remove power and TNT connections before handling the equipment.

10. Lightning
For added protection for this equipment during a lightning storm, or when it is left unattended and unused for long periods of time, unplug it from the wall outlet and disconnect the antenna or cable system. This will prevent damage to the equipment due to lightning and power-line surges.

11. Overloading
Do not overload wall outlets and extension cords as this can result in the risk of fire or electric shock.

12. Objects and Liquids
Never push objects of any kind through openings of this equipment as they may touch dangerous voltage points or short out parts that could result in a fire or electric shock. Never spill liquid of any kind on the equipment.

13. Servicing
Do not attempt to service this equipment yourself. Refer all servicing to qualified service personnel.

14. Damage requiring Service
Unplug this equipment from the wall outlet and refer servicing to qualified service personnel under the following conditions:

- A. When the power-supply cord or the plug has been damaged.
- B. If liquid is spilled, or objects have fallen into the equipment.
- C. If the equipment has been exposed to rain or water.
- D. If the equipment does not operate normally by following the operating instructions, adjust only those controls that are covered by the operating instructions as an improper adjustment of other controls may result in damage and will often require extensive work by a qualified technician to restore the equipment to its normal operation.
- E. If the equipment has been dropped, or the cabinet damaged.
- F. When the equipment exhibits a distinct change in performance — this indicates a need for service.

15. Replacement Parts
When replacement parts are required, be sure the service technician has used replacement parts specified by the manufacturer or that have the same characteristics as the original part. Unauthorized substitutions may result in fire, electric shock or other hazards.

16. Safety Check
Upon completion of any service or repairs to this equipment, ask the service technician to perform safety checks to determine that the equipment is in proper operating condition.

17. Field Installation
This installation should be made by a qualified service person and should conform to all local codes.

18. Correct Batteries
Warning: Risk of explosion if battery is replaced by an incorrect type. Dispose of used batteries according to the instructions.

19. Tmra
A manufacturer's maximum recommended ambient temperature (Tmra) for the equipment must be specified so that the customer and installer may determine a suitable maximum operating environment for the equipment.

20. Elevated Operating Ambient Temperature
If installed in a closed or multi-unit rack assembly, the operating ambient temperature of the rack environment may be greater than room ambient. Therefore, consideration should be given to installing the equipment in an environment compatible with the manufacturer's maximum rated ambient temperature (Tmra).

21. Reduced Air Flow
Installation of the equipment in the rack should be such that the amount of airflow required for safe operation of the equipment is not compromised.

22. Mechanical Loading
Mounting of the equipment in the rack should be such that a hazardous condition is not caused by uneven mechanical loading.

23. Circuit Overloading
Consideration should be given to connection of the equipment to supply circuit and the effect that overloading of circuits might have on over current protection and supply wiring. Appropriate consideration of equipment nameplate ratings should be used when addressing this concern.

24. Reliable Earthing (Grounding)
Reliable grounding of rack mounted equipment should be maintained. Particular attention should be given to supply connections other than direct connections to the branch circuit (e.g., use of power strips).

WEEE (Waste Electrical & Electronic Equipment)

Correct Disposal of This Product
(Applicable in the European Union and other European countries with separate collection systems)



This marking shown on the product or its literature, indicates that it should not be disposed with other household wastes at the end of its working life. To prevent possible harm to the environment or human health from uncontrolled waste disposal, please separate this from other types of wastes and recycle it responsibly to promote the sustainable reuse of material resources.

Household users should contact either the retailer where they purchased this product, or their local government office, for details of where and how they can take this item for environmentally safe recycling.

Business users should contact their supplier and check the terms and conditions of the purchase contract. This product should not be mixed with other commercial wastes for disposal.

Table of Contents

Chapter 1 — Introduction	1
Feature	1
Technical Overview	1
Chapter 2 — Installation	3
Package Contents	3
Required Installation Tools	3
Video Input	3
Video Loop Through	4
eSATA Port	4
Network Port	4
Video Out	4
Alarm Input/Output	4
RS232C Port	5
Factory Reset Switch	5
RS485 Port	5
Audio In/Out	5
Power Cord Connector	6
Chapter 3 — Configuration	7
Front Panel Controls	7
Power LED	7
HDD LED	7
Camera Buttons	7
Menu Button	8
Copy Button	8
Esc Button	8
Play/Stop Button	8
Alarm Button	8
Sequence Button	8
PTZ Button	8
Mode Button	8
Arrow Buttons	8
Enter Button	9
Jog Dial	9
Shuttle Ring	9
USB Port	9
Remote Control Buttons	10
ID Button	10
Camera Buttons	10
Sequence Button	10
Login/Logout Button	10
Arrow Buttons	11
Menu Button	11
Playback Buttons	11
Alarm Button	11
Layout Button	11
Zoom Button	11

PTZ Button.....	11
Enter Button.....	11
Esc Button	11
PTZ Control Buttons	12
Copy Button.....	12
Play/Stop Button.....	12
Turning on the Power.....	12
Initial Unit Setup.....	12
Setup Screen	13
System Setup.....	13
General	13
Date/Time	21
User	22
Storage	24
Monitoring.....	25
Capacity Estimator	26
Recording Setup	27
General	27
Schedule.....	28
Pre-Event.....	30
Archive.....	31
Event Setup	32
Motion.....	32
Alarm-In	33
Video Loss.....	34
Video Blind.....	35
Text-In.....	35
Network.....	37
Network Setup	38
General	38
IP Address	40
DVRNS	42
RTSP	43
Notification.....	44
Device Setup.....	46
Local Audio.....	46
Network Audio	47
Digital Deterrent.....	48
Alarm-Out	50
Remote Control	51
Display Setup.....	51
OSD.....	51
Primary Monitor	52
Spot Monitor	53
Status Setup	54
Event.....	54
Storage	55
Camera Setup.....	55
General	55
PTZ.....	56
Network Camera.....	57

Chapter 4 — Operation	61
Turning on the Power.....	61
Live Monitoring.....	61
Live Monitoring Menu	62
Active Cameo Mode	64
Zoom Mode.....	64
PTZ Mode	64
Event Monitoring.....	65
Covert Camera	66
Spot Monitoring	66
Recording Video	66
Panic Recording	67
Recording Audio	67
Playing Recorded Video	67
Searching Video.....	68
Search Menu	69
Event Log Search.....	71
Record Table Search.....	73
Motion Search	74
Text-In Search	76
EZ Search.....	77
Bookmarks.....	78
Clip-Copy.....	78
Print	80
Disk Mirroring.....	80
Appendix	83
USB Hard Disk Drive Preparation.....	83
Text-In Search Examples.....	83
Search Example I	83
Search Example II	84
Speco Remote	85
Web Monitoring Mode	86
Web Search Mode.....	87
Time Overlap	88
Remote Setup of Network Devices.....	89
Connector Pin Outs.....	92
I/O Connector Pin Outs	92
RS485 Connector Pin Outs	92
Map of Screens.....	93
Error Code Notices	94
System Log Notices	95
Troubleshooting	95
Specifications.....	96

List of Illustrations

Figure 1 : Typical DVR installation.....	2
Figure 2 : 16-Channel DVR rear panel.....	3
Figure 3 : 16-Channel DVR front panel.....	7
Figure 4 : Infrared remote control.....	10
Figure 5 : Login screen.....	12
Figure 6 : Logout screen.....	12
Figure 7 : Setup screen.....	13
Figure 8 : System – General setup screen.....	14
Figure 9 : System – Date/Time setup screen.....	21
Figure 10 : System – User setup screen.....	22
Figure 11 : System – Storage setup screen.....	24
Figure 12 : System – Monitoring setup screen.....	25
Figure 13 : System – Capacity Estimator setup screen.....	26
Figure 14 : Record – General setup screen.....	27
Figure 15 : Record – Schedule setup screen.....	28
Figure 16 : Schedule – Settings (Advanced Mode) setup screen.....	29
Figure 17 : Record – Pre-Event setup screen.....	30
Figure 18 : Record – Archive setup screen.....	31
Figure 19 : Event – Motion setup screen.....	32
Figure 20 : Event – Alarm-In setup screen.....	33
Figure 21 : Event – Video Loss setup screen.....	34
Figure 22 : Event – Video Blind setup screen.....	35
Figure 23 : Event – Text-In setup screen.....	36
Figure 24 : Text-In Device screen.....	36
Figure 25 : Event – Network setup screen.....	37
Figure 26 : Network – General setup screen.....	38
Figure 27 : Network – IP Address (Manual) setup screen.....	40
Figure 28 : Network – DVRNS setup screen.....	42
Figure 29 : Network – RTSP setup screen.....	43
Figure 30 : Network – Notification setup screen.....	44
Figure 31 : Device – Local Audio setup screen.....	47
Figure 32 : Device – Network Audio setup screen.....	47
Figure 33 : Device – Digital Deterrent setup screen.....	48
Figure 34 : Device – Alarm-Out setup screen.....	50
Figure 35 : Device – Remote Control setup screen.....	51
Figure 36 : Display – OSD setup screen.....	51
Figure 37 : Display – Primary Monitor setup screen.....	52
Figure 38 : Display – Spot Monitor setup screen.....	53
Figure 39 : Status – Event setup screen.....	54
Figure 40 : Status – Storage setup screen.....	55
Figure 41 : Camera – General setup screen.....	56
Figure 42 : Camera – PTZ setup screen.....	56
Figure 43 : Camera – Network Camera setup screen.....	57
Figure 44 : Live Monitoring menu.....	61
Figure 45 : PTZ Select Camera menu.....	64
Figure 46 : PTZ Preset menu.....	65
Figure 47 : Select Playback Camera menu.....	67
Figure 48 : Search menu.....	68
Figure 49 : Event Log Search screen.....	71
Figure 50 : Record Table Search screen.....	73
Figure 51 : Motion Search screen.....	74
Figure 52 : Text-In Search screen.....	76
Figure 53 : Bookmarks screen.....	78
Figure 54 : Clip-Copy screen.....	78
Figure 55 : Print screen.....	80
Figure 56 : System – Storage setup screen.....	81

Chapter 1 — Introduction

Feature

Your color digital video recorder (DVR) provides recording capabilities for eight or 16 camera inputs. It provides exceptional picture quality in both live and playback modes, and offers the following features:

NOTE: Your DVR can record both analog CCTV video input and network video input. For a list of supported network devices (network cameras and network video transmitters), contact your installer or distributor.

- 8 or 16 Composite Video Input Connectors
- Compatible with Color (NTSC or PAL) and B&W (CCIR and EIA-170) Video Sources
- Auto Detection for NTSC and PAL
- H.264 and JPEG Dual Codec
- Multiple Monitor Connectors: 1 HDMI, 1 VGA, 1 Spot
- Multiple Search Engines (Date/Time, Record Table, Event, EZ Search)
- Real-time Recording (480/400 Images per Second (NTSC/PAL) with Very High (4CIF/960H) Resolution)
- “Loop-Through” Video Connectors
- Continuous Recording in Disk Overwrite Mode
- Pentaplex Functionality (Monitoring, Recording, Playback, Archiving and Transmission at the same time)
- Video Archiving via eSATA Interface
- 2 USB 2.0 Ports
- Continues Recording while Archiving, Transmitting to Remote Site and during Playback
- User-friendly Graphical User Interface (GUI) Menu System
- Multiple Recording Modes (Time-lapse, Pre-event, Event and Panic)
- 4 Network Video Inputs
- Two-way Audio Communication
- 4-Channel Audio Recording and 1-Channel Audio Playback
- Text Input for ATM and POS
- Alarm Connections Include: Input, Output and Reset Input
- Built-in Alarm Buzzer
- Live or Recorded Video Access via Ethernet
- Time Synchronization using industry standard protocol
- Built-in DVD RW Drive
- IR Remote Control
- Self-diagnostics with automatic notification including hard disk drive S.M.A.R.T. protocol

Technical Overview

In addition to replacing both a time-lapse VCR and a multiplexer in a security installation, your DVR has many features that make it much more powerful and easier to use than even the most advanced VCR.

The DVR converts analog NTSC or PAL video to digital images and records them on a hard disk drive. Using a hard disk drive allows you to access recorded video almost instantaneously; there is no need to rewind tape. The technology also allows you to view recorded video while the DVR continues recording video.

Digitally recorded video has several advantages over analog video recorded on tape. There is no need to adjust tracking. You can freeze frames, fast forward, fast reverse, slow forward and slow reverse without image streaking or tearing. Digital video can be indexed by time or events, and you can instantly view video after selecting the time or event.

Your DVR can be set up for event or time-lapse recording. You can define times to record, and the schedule can change for different days of the week and user defined holidays.

The DVR can be set up to alert you when the hard disk drive is full, or it can be set to record over the oldest video once the disk is full.

Your DVR supports disk mirroring functions to prevent any unexpected loss of recorded video data that might be caused by disk damage or corruption.

Your DVR uses a proprietary encryption scheme making it nearly impossible to alter video.

Your DVR can be used to monitor video from network video transmitters and/or network cameras, record monitored video and play back recorded video.

You can view video and control your DVR remotely by connecting via Ethernet. There is an eSATA port that can be used to record video or archive to external hard disk drives, and there are two USB ports that can be used to upgrade the system or copy video clips to external hard disk and flash drives.

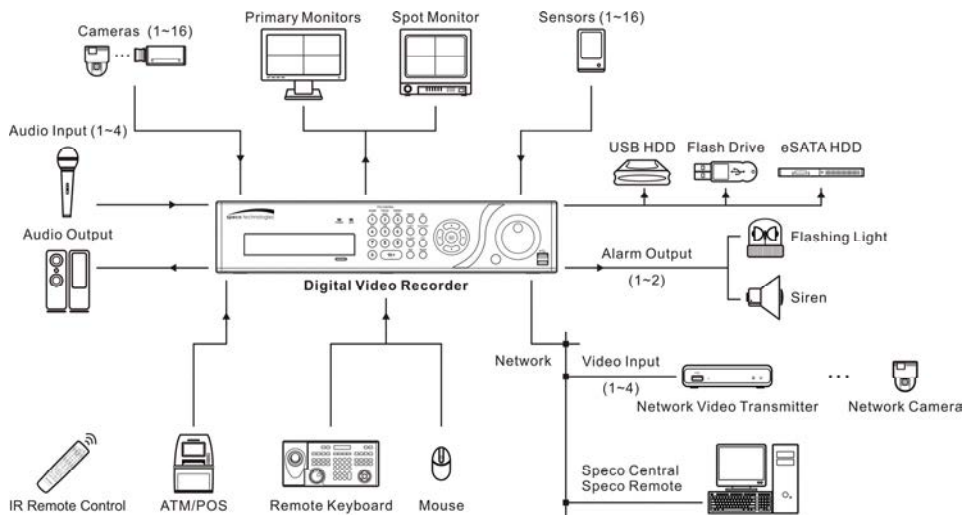

Figure 1 : Typical DVR installation.

NOTE: This manual covers the 8- and 16-channel digital video recorders. The DVRs are identical except for the number of cameras and alarms that can be connected and the number of cameras that can be displayed. For simplicity, the illustrations and descriptions in this manual refer to the 16-camera model.

Chapter 2 — Installation

Package Contents

The package contains the following:

- Digital Video Recorder
- Power Cord
- Operation Instruction (This Document)
- Speco Central Software CD and Operation Instruction
- Rack-mount Kit
- Infrared Remote Control

Required Installation Tools

No special tools are required to install the DVR. Refer to the installation manuals for the other items that make up part of your system.

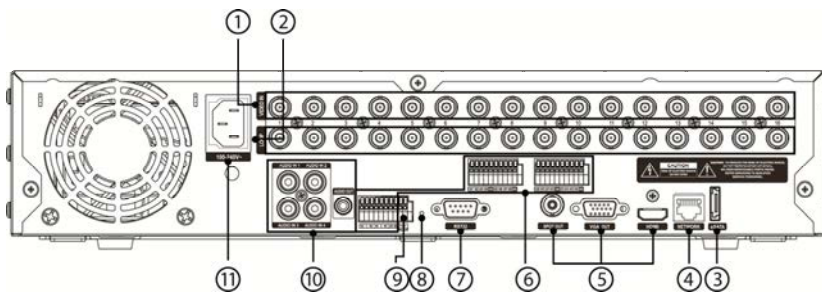

Figure 2 : 16-Channel DVR rear panel.

- | | | |
|----------------|------------------------|----------------------|
| ① Video Input | ② Video Loop Through | ③ eSATA Port |
| ④ Network Port | ⑤ Video Out | ⑥ Alarm Input/Output |
| ⑦ RS232 Port | ⑧ Factory Reset Switch | ⑨ RS485 Port |
| ⑩ Audio In/Out | ⑪ Power Cord Connector | |

Your DVR can be used with either NTSC or PAL equipment.

NOTE: You cannot mix NTSC and PAL equipment. For example you cannot use a PAL camera and an NTSC monitor.

Video Input

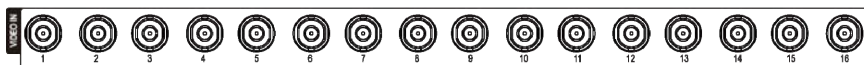

Connect the coaxial cables from the video sources to the BNC Video In connectors.

Video Loop Through

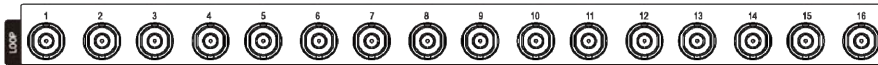

If you would like to connect your video source to another device, you can use the Loop BNC connectors.

NOTE: The Loop BNC connectors are auto terminated. Do NOT connect a cable to the Loop BNC unless it is connected to a terminated device because it will cause poor quality video.

eSATA Port



An eSATA port is provided to connect external storage devices for recording or archiving video. Connect the external eSATA hard disk drive (RAID) cable to the eSATA port.

CAUTION: Do NOT connect or disconnect eSATA devices while the DVR power is on. The DVR must be powered down to connect or disconnect eSATA devices. Power up eSATA devices so they are ready for operation before powering up the DVR. Power down eSATA devices after powering down the DVR and then disconnect eSATA devices.

Network Port



The DVR can be networked using the 10Mb/1Gb Ethernet connector. Connect a Cat5 cable with an RJ-45 jack to the DVR connector. The DVR can be networked with network cameras or video transmitters for remote monitoring and recording, and can also be networked with a computer for remote monitoring, searching, configuration and software upgrades. See *Chapter 3 — Configuration* for configuring the Ethernet connections.

CAUTION: The network connector is not designed to be connected directly with cable or wire intended for outdoor use.

Video Out



An HDMI (High-Definition Multimedia Interface) connector is provided so that you can use an HDMI monitor as your primary monitor.

A VGA OUT connector is provided so that you can use a standard, multi-sync computer monitor as your primary monitor. Use the cable supplied with your monitor to connect it to the DVR.

Connect the spot monitor to the SPOT OUT connector as needed.

NOTE: Connect the monitor before the DVR boots so that video can be displayed on the monitor with the resolution you have set during system setup.

Alarm Input/Output



NOTE: To make connections on the Alarm Connector Strip, press and hold the button and insert the wire in the hole below the button. After releasing the button, tug gently on the wire to make certain it is connected. To disconnect a wire, press and hold the button above the wire and pull out the wire.

AI 1 to 16 (Alarm-In): You can use external devices to signal the DVR to react to events. Mechanical or electrical switches can be wired to the AI (Alarm-In) and GND (Ground) connectors. The threshold voltage of electrical switches for NC (Normally Closed) is above 2.4V and for NO (Normally Open) is below 0.3V, and should be stable at least 0.5 seconds to be detected. The voltage range of alarm input is from 0V to 5V. See *Chapter 3 — Configuration* for configuring alarm input.

GND (Ground): Connect the ground side of the Alarm input and/or alarm output to the GND connector.

NOTE: All the connectors marked GND are common.

NC/NO (Relay Alarm Outputs): The DVR can activate external devices such as buzzers or lights. Connect the device to the C (Common) and NC (Normally Closed) or C and NO (Normally Open) connectors. NC/NO is a relay output which sinks 2A@125VAC and 1A@30VDC. See *Chapter 3 – Configuration* for configuring alarm output.

ARI (Alarm Reset In): An external signal to the Alarm Reset In can be used to reset both the Alarm Out signal and the DVR's internal buzzer. Mechanical or electrical switches can be wired to the ARI (Alarm Reset In) and GND (Ground) connectors. The threshold voltage is below 0.3V and should be stable at least 0.5 seconds to be detected. Connect the wires to the ARI and GND connectors.

RS232C Port



An RS232 port is provided to connect a remote control keyboard.

Factory Reset Switch



The DVR has a Factory Reset switch to the left of the RS232 connector on the rear panel. This switch will only be used on the rare occasions that you want to return all the settings to the original factory settings.

CAUTION: When using the *Factory Reset*, you will lose any settings you have saved.

To reset the unit, you will need a straightened paperclip:

1. Turn the DVR off.
2. Turn it on again.
3. While the DVR is initializing, the front panel LEDs will blink. When the front panel LEDs blink, poke the straightened paperclip into the unlabeled hole to the left of the RS232 connector.
4. Hold the switch until the DVR's internal buzzer sounds twice.
5. Release the reset switch. All of the DVR's settings are now at the original settings it had when it left the factory.

RS485 Port



The DVR can be controlled remotely by an external device or control system, such as a control keyboard, using RS485 half-duplex serial communications signals. The RS485 connector can also be used to control PTZ (pan, tilt, zoom) cameras. Connect RX+/TX+ and RX-/TX- of the control system to the + and – (respectively) of the DVR. See *Chapter 3 – Configuration* and the PTZ camera or remote controller manufacturer's manual for configuring the RS485 connection.

Audio In/Out

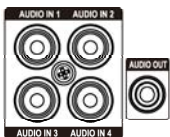

Your DVR can record audio from up to four sources. Connect the audio sources to Audio In 1, Audio In 2, Audio In 3 and Audio In 4 as needed using RCA jacks. Connect Audio Out to your amplifier.

NOTE: It is the user's responsibility to determine if local laws and regulations permit recording audio.

The DVR does not have amplified audio output, so you will need a speaker with an amplifier. The DVR does not have a pre-amplifier for audio input, so the audio input should be from an amplified source, not directly from a microphone.

Power Cord Connector

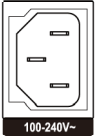

Connect the AC power cord to the DVR and then to a wall outlet.

WARNING: ROUTE POWER CORDS SO THAT THEY ARE NOT A TRIPPING HAZARD. MAKE CERTAIN THE POWER CORD WILL NOT BE PINCHED OR ABRADED BY FURNITURE. DO NOT INSTALL POWER CORDS UNDER RUGS OR CARPET. THE POWER CORD HAS A GROUNDING PIN. IF YOUR POWER OUTLET DOES NOT HAVE A GROUNDING PIN RECEPTACLE, DO NOT MODIFY THE PLUG. DO NOT OVERLOAD THE CIRCUIT BY PLUGGING TOO MANY DEVICES IN TO ONE CIRCUIT.

Your DVR is now ready to operate. Refer to *Chapter 3 – Configuration* and *Chapter 4 – Operation*.

Chapter 3 — Configuration

NOTE: Your DVR should be completely installed before proceeding. Refer to *Chapter 2 — Installation*.

Front Panel Controls

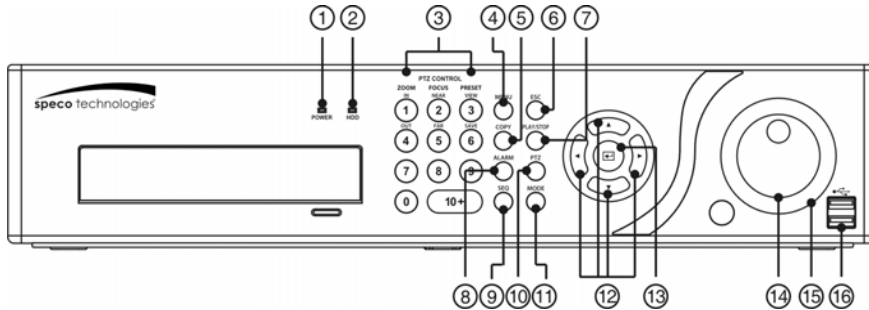

Figure 3 : 16-Channel DVR front panel.

- | | | | |
|-------------------|--------------|--------------------|-----------------|
| ① Power LED | ② HDD LED | ③ Camera Buttons | ④ Menu Button |
| ⑤ Copy Button | ⑥ Esc Button | ⑦ Play/Stop Button | ⑧ Alarm Button |
| ⑨ Sequence Button | ⑩ PTZ Button | ⑪ Mode Button | ⑫ Arrow Buttons |
| ⑬ Enter Button | ⑭ Jog Dial | ⑮ Shuttle Ring | ⑯ USB Port |

The front panel looks and operates much like a VCR combined with a multiplexer. The following describes each button and control. Take a few minutes to review the descriptions. You will use these to initially set up your DVR and for daily operations.

NOTE: The infrared sensor on the DVR is just to the left of the Jog Dial. Make certain that nothing blocks the sensor, or the remote control will not function properly.

When you use wireless communication devices (such as Wi-Fi or Bluetooth) near the DVR, the remote control might not function properly.

You can also use a USB mouse (not supplied) to navigate through the screens and menus much like you would on a computer.

Power LED

The POWER LED is lit when the unit is On.

HDD LED

The HDD LED flickers when the DVR is recording or searching video on the hard disk drive.

Camera Buttons

Pressing the individual camera buttons will cause the selected camera to display full screen. Pressing the buttons 1 to 4 toggles the camera selection between local cameras and network cameras. For example, pressing the button 1 displays the local camera number 1 and pressing the button 1 again displays the network camera number 1. Buttons are also used to enter passwords.

NOTE: When selecting the camera channel from 10 to 16, press the 10+ and then 0 to 6.

In the PTZ mode, pressing the button 1 zooms in the screen and the button 4 zooms out the screen, pressing the button 2 focuses near and button 5 focuses far, and pressing the button 3 moves to the preset and button 6 saves the preset.

Menu Button

In the Live Monitoring mode and Search mode, pressing the **MENU** button displays the menu icons to the right edge of the screen.

Copy Button

Pressing the **COPY** button allows you to copy video clips.

Esc Button

During menu setup, pressing the **ESC** button closes the current menu or setup dialog box.

Play/Stop Button

Pressing the **PLAY/STOP** button enters the playback mode, and pressing the button again exits the playback mode. When entering the playback mode, video is paused.

When in one of the multi-view formats, pressing this button enters the Triplex mode. The DVR supports the Triplex function: monitoring, recording and playing back at the same time.

Alarm Button

The **ALARM** button has two functions. First, it will reset the DVR's outputs including the internal buzzer during an alarm. Second, it will display the event log when you are in the live monitoring mode unless there is an active alarm. This operation can be user password protected.

Sequence Button

When in the live mode, pressing the **SEQ** button displays live channels sequentially.

PTZ Button

Pressing the **PTZ** button enters the PTZ (Pan/Tilt/Zoom) mode and the PTZ icon flickers. Pressing the button again exits the PTZ mode. Pressing the arrow buttons or **MENU** button allows you to control properly configured cameras.

Mode Button

Pressing the **MODE** button toggles between different display formats. The available formats are: PIP, 2x2, 3x2, 3x3, 4x3, 4x4 or 5x4.

Arrow Buttons

These buttons are used to navigate through menus and GUI. You can also use them to change numbers by highlighting a number in the menu and using the Up and Down arrow buttons to increase or decrease the number's value.

These buttons are also used to control Pan and Tilt when in the PTZ mode. When in the PIP display format, pressing the Up and Down arrow buttons moves the position of the small screen counter-clockwise and clockwise, and pressing the Left and Right buttons moves through screen pages.







Enter Button

The  (Enter) button selects a highlighted item or completes an entry that you have made during system setup.

Jog Dial

When in the playback mode, you can play video forward image-by-image by turning the Jog Dial clockwise and backward image-by-image by turning the Jog Dial counterclockwise. When in the PIP mode, you can make the PIP screen smaller by turning the Jog Dial clockwise and larger by turning the Jog Dial counterclockwise. When in the Setup mode, you can change number values by highlighting the item in the menu and turning Jog Dial clockwise or counterclockwise to increase or decrease the number.

Shuttle Ring

The Shuttle Ring only functions in the Playback mode. The Shuttle Ring is spring loaded and returns to the center position when released. Turning the ring clockwise plays video forward. Turning the ring counterclockwise plays video backward. Playback speed varies with the amount the ring is turned. The playback speeds are , , , , , , . When you release the ring, it snaps back to the center position and the video pauses.

USB Port

Two USB ports on the front panel are provided to connect external hard disk or flash drives for video clip copying or system upgrades. Position external drives close enough to the DVR so that you can make the cable connections, usually less than 6 feet. Use the USB cable provided with the hard disk drive to connect it to the DVR.

A USB mouse (not supplied) can be connected to one of the ports. You can use the mouse to navigate through the screens and menus much like you would on a computer.

A PostScript™ USB printer (not supplied) can be connected to one of the ports. You can print selected images resulting from a search. *Refer to Chapter 4 — Operation, Searching Video.*

A USB to Serial converter can be connected to the USB port. Multiple text-in devices can be used with a USB to Serial converter.

Remote Control Buttons

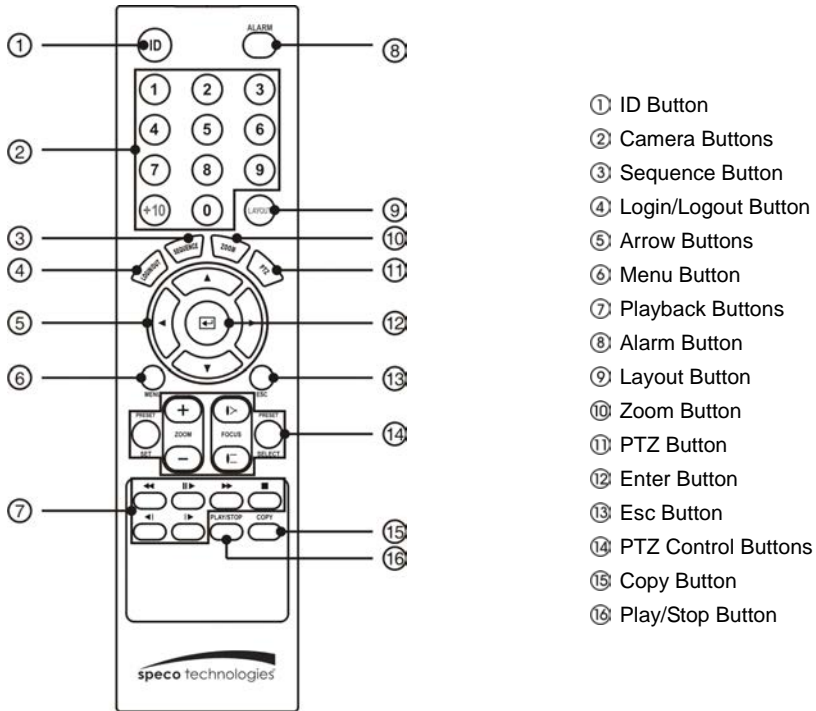

Figure 4 : Infrared remote control.

NOTE: For simplicity, the button descriptions in this manual refer to the front panel buttons.

ID Button

If a DVR System ID is set to 0, the infrared remote control will control that DVR without any additional operations. (Refer to the *System General* setup screen in this chapter for further information on setting the System ID.) If the system ID is 1 to 16, you must to press the **ID** button and then press the number button (1 to 16 (+10 & 6)) in order to control that DVR. If the System ID of two or more DVRs is set to 0, those DVRs will react to the infrared remote control at the same time.

Camera Buttons

Pressing the individual camera buttons will cause the selected camera to display full screen. Buttons 1 to 9 are also used to enter passwords.

Sequence Button

When in the Live Monitoring mode, pressing the **SEQUENCE** button displays live channels sequentially.

Login/Logout Button

Pressing the **LOGIN/OUT** button displays the Login or Logout screen.















Arrow Buttons

These buttons are used to navigate through menus and GUI. You can also use them to change numbers by highlighting a number in the menu and using the Up and Down arrow buttons to increase or decrease the number's value. These buttons are also used to control Pan and Tilt when in the PTZ mode.

Menu Button

In the Live Monitoring mode and Search mode, pressing the **MENU** button displays the menu icons to the right edge of the screen.

Playback Buttons

- **Rewind:** Pressing the  button plays video backward at high speed. Pressing the button again toggles the playback speed from ,  and .
- **Play/Pause:** Pressing the  button plays back video at regular speed and pressing the button again pauses video. The screen displays  when the DVR is in the Pause mode and the screen displays  when the DVR is playing back video.
- **Fast Forward:** Pressing the  button plays video forward at high speed. Pressing the button again toggles the playback speed from ,  and .
- **Stop:** Pressing the  button stops playback and enters the Live Monitoring mode.
- **Backward:** When in the pause mode, pressing the  button moves to the previous image.
- **Forward:** When in the pause mode, pressing the  button moves to the next image.

In the Live Monitoring mode, pressing any playback button enters to the Search mode.

Alarm Button

Pressing the **ALARM** button resets the DVR's outputs including the internal buzzer during an alarm.

Layout Button

Pressing the **LAYOUT** button toggles between different display formats. The available formats are: 5x4, 4x4, 4x3, 3x3, 3x2, 2x2 and PIP.

Zoom Button

Pressing the **ZOOM** button zooms the current image on the screen. A PIP with a rectangle temporarily displays showing what area of the screen has been enlarged. You can use the arrow buttons to move the rectangle to another area.

PTZ Button

Pressing the **PTZ** button enters the PTZ (Pan/Tilt/Zoom) mode which allows you to control properly configured cameras.

Enter Button

The  (Enter) button selects a highlighted item or completes an entry that you have made during system setup.

Esc Button

During menu setup, pressing the **ESC** button closes the current menu or setup dialog box.

PTZ Control Buttons

While in the PTZ mode, the **PRESET** buttons are used to save Presets and load a Preset View, the **ZOOM** buttons are used to Zoom In and Zoom Out, and the **FOCUS** buttons are used for Near Focus and Far Focus.

Copy Button

Pressing the **COPY** button allows you to copy video clips.

Play/Stop Button

Pressing the **PLAY/STOP** button enters the playback mode, and pressing the button again exits the playback mode. When entering the playback mode, video is paused. Pressing the **▶** button plays back video at regular speed. The screen displays **||** when the DVR is in the Pause mode and the screen displays **▶** when the DVR is playing back video.

When in one of the multi-view formats, pressing this button enters the Triplex mode. The DVR supports the Triplex function: monitoring, recording and playing back at the same time.

Turning on the Power

Connecting the power cord to the DVR turns on the unit. The unit takes approximately 60 seconds to initialize.

Initial Unit Setup

Before using your DVR for the first time, you will want to establish the initial settings. This includes items such as time and date, display language, camera, remote control, record mode, network and password. Your DVR can be set up using various screens and dialog boxes.

Throughout the screens you will see **↔**. Highlighting the **↔** and pressing the **↔** button gives you the opportunity to reset that screen to its default settings. After you are finished with any setup screen, you can highlight **Save** and press the **↔** button to save the changes and exit the screen. If you do not wish to save the changes, highlight **Cancel** and press the **↔** button to exit the screen.

Press the **MENU** button or move the mouse pointer on the right edge of the screen and then select **🔑** (Login) in the Live Monitoring menu to enter the setup screens. The Login screen appears.



Select a User and enter the password by pressing the appropriate combination of Camera number buttons and then the **↔** button. There is no default password when logging in the admin user for the first time.

Figure 5 : Login screen.

NOTE: To assure the secure management of the system, setting up a password is strongly recommended.

If you cannot use the front panel buttons, click the **⋮** button using the mouse to enter a password, and the virtual keyboard displays. See instructions below for using the virtual keyboard.

To log the user out of the system, press the **MENU** button or move the mouse pointer on the right edge of the screen and then select **🔒** (Logout) in the Live Monitoring menu. The Logout screen displays asking you to confirm whether or not you want to log out the current user.



Figure 6 : Logout screen.

Setup Screen

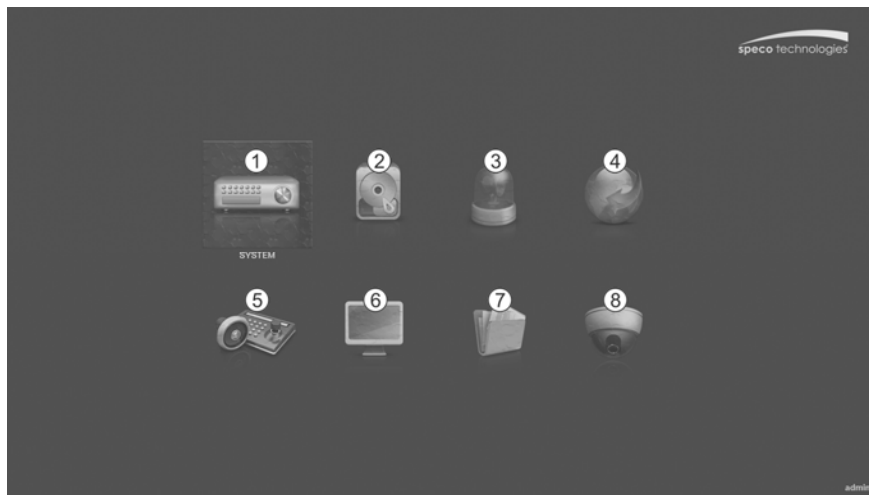







Figure 7 : Setup screen.

- | | | | |
|----------|-----------|----------|-----------|
| ① System | ② Record | ③ Event | ④ Network |
| ⑤ Device | ⑥ Display | ⑦ Status | ⑧ Camera |

Press the **MENU** button or move the mouse pointer on the right edge of the screen and then select  (Setup) in the Live Monitoring menu to enter the setup screen.

While setting up the DVR, there will be many opportunities to enter names and titles. When making these entries, a Virtual Keyboard will appear.



Use the arrow keys to highlight the character you want in the name or title and press the  button. That character appears in the title bar and the cursor moves to the next position. Pressing  toggles between the upper and lower case keyboards,  backspaces, and  deletes entered characters.

Special characters can be created using ^ and a capital letter; e.g., ^J for NL (New Line), ^M for CR (Carriage Return). Special characters are commonly used by text input devices and will be useful when performing Text-In Searches.

System Setup

General

Highlight General and press the  button, and the General screen appears.

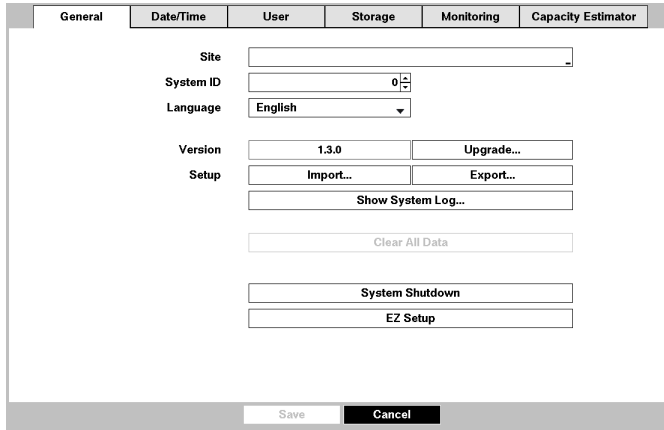

Figure 8 : System – General setup screen.

In the **General** screen, you can name the site location, assign a System ID number, select the language the screens are displayed in, display software version number, upgrade the software, show the System Log, display recorded time data, and clear all data.

Highlight the **Site** box and press the button. A virtual keyboard appears that you can use to enter a Site Name. Once you have entered your title, highlight OK and press the button.

Highlight the box beside **System ID** and press the button. Change the number by highlighting it and using the Up and Down arrow buttons to increase and decrease the number from 0 to 99.

NOTE: The System ID number is used to identify the unit when it is connected with other DVRs through the RS485 port. You cannot use the same ID number for two or more DVRs that are in the same RS485 network. It is possible to have multiple DVRs with System ID 0 that are in the same area as long as they are not part of an RS485 network. If this is the case, all will be controlled at the same time when using the infrared remote control.

Highlight the box beside **Language** and press button. A drop-down menu displays the available languages. Highlight the desired language and press the button.

The box beside **Version** displays the software version of the DVR.





To upgrade the software, connect a USB device containing the upgrade package file to the DVR. Highlight **Upgrade...** and press the button. The **Upgrade** screen appears. The screen displays the upgrade package file names that are available. The “.rui” indicates that the file is for software upgrades and “.ofi” indicates that the file is for optical drive firmware upgrades.

Select the desired file and press the button. Highlighting the **Install** button and pressing the button will install the selected software package. Highlighting the **Cancel** button and pressing the button will close the window without upgrading the software. If the upgrade package file is not installed on the DVR properly, you will get an error message. The system restarts automatically after completing the upgrade.

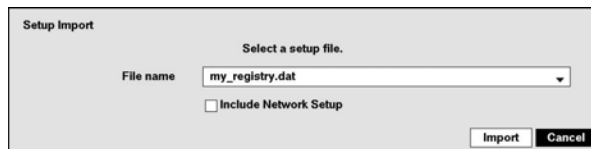

CAUTION: The USB device must be FAT16 or FAT32 format.



You can import saved DVR settings or export the current DVR settings. To import saved DVR settings, connect the USB device containing the setup file (.dat) to the DVR. Highlight Setup – Import... and press the  button. Select the desired setup file and press the Import button to import the selected settings and change the DVR settings accordingly. Highlight Include Network Setup and press the  button to toggle between On and Off. When set to Off, the network settings will not be changed.



The Setup Export dialog box features a title bar with the text "Setup Export". Below the title bar is a text input field labeled "File name" with a dropdown arrow on the right. At the bottom right of the dialog are two buttons: "Export" and "Cancel".

To export the current DVR settings, connect the USB device to the DVR. Highlight Setup – Export... and press the  button. Highlight the box beside File name and press the  button. A virtual keyboard allows you to enter the file name. Selecting Export will save the current settings in .dat file format on the USB device.

NOTE: Even after changing the DVR settings by importing saved settings, the time-related settings (Date/Time, Time Zone and Daylight Saving Time) will NOT be changed.



CAUTION: The USB device must be FAT16 or FAT32 format.

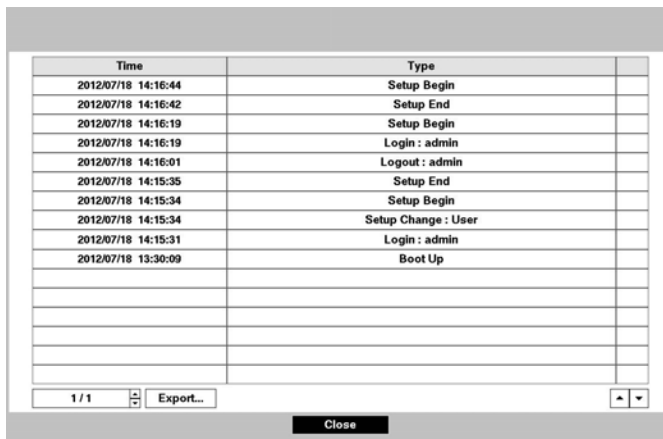

Highlight Show System Log... and press the  button to display the System Log.



The System Log screen displays a table of system activities. The table has two columns: "Time" and "Type". Below the table are navigation controls, including a page indicator "1 / 1", an "Export..." button, and a "Close" button.

Time	Type
2012/07/18 14:16:44	Setup Begin
2012/07/18 14:16:42	Setup End
2012/07/18 14:16:19	Setup Begin
2012/07/18 14:16:19	Login : admin
2012/07/18 14:16:01	Logout : admin
2012/07/18 14:15:35	Setup End
2012/07/18 14:15:34	Setup Begin
2012/07/18 14:15:34	Setup Change : User
2012/07/18 14:15:31	Login : admin
2012/07/18 13:30:09	Boot Up

The System Log screen lists system activities (up to 5,000 from the latest) that have occurred along with the time and date. The  icon will be displayed in the last column for system activities of the remote site. You can scroll through the log pages by using the Up and Down arrows, or you can go directly to a log page by entering the log page number in the box at the bottom left of the screen. Highlight Close and press the  button to exit the screen.

To export the system log information, connect the USB device to the DVR. Highlight Export... and press the  button. Highlight the box beside File name and press the  button. A virtual keyboard allows you to enter the file name. Selecting Export will save the log information in .txt file format on the USB device.

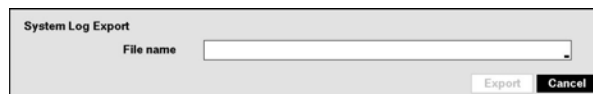

The System Log Export dialog box features a title bar with the text "System Log Export". Below the title bar is a text input field labeled "File name" with a dropdown arrow on the right. At the bottom right of the dialog are two buttons: "Export" and "Cancel".

NOTE: When opening the saved .txt file, setting to the proper character encoding and using fixed width fonts will be required to read the file properly.

Highlighting Clear All Data and pressing the  button will clear all video data. You will be asked to verify that you wish to clear all data before the DVR erases the video data. Clear All Data will not clear the System Log.

Highlight System Shutdown and press the  button. The Shutdown screen displays asking you to confirm whether or not you want to shut the system down.



After selecting Shutdown and pressing the  button, a screen will appear telling you when it is safe to disconnect power.

Highlight EZ Setup and press the  button. The EZ Setup screen appears and guides you through configuring the system for basic operation.

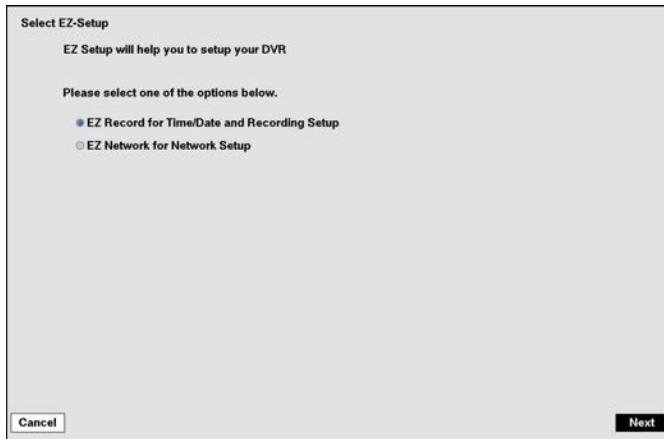

Select either EZ Record or EZ Network and select the Next button to start the selected setup.

NOTE: Selecting the *Cancel* button throughout the screens exits the EZ Setup without saving your changes and returns to the System – General setup screen.



If you selected the EZ Record, selecting the Next button starts the EZ Record.

EZ Record (Step 1/3)
Date/Time Setup

Date: Format

Time: Format

Time Zone:

Use Daylight Saving Time

Date/Time Setup

- Date: Set the system date and select the date format.
- Time: Set the system time and select the time format.
- Time Zone: Select your time zone.
- Use Daylight Saving Time: Selecting the box sets the system to use daylight saving time.

NOTE: The Date/Time will be set, and the clock will start when you click the **Next** button.

The Time Zone can also be selected on the map below by pressing the Left and Right buttons or scrolling the mouse wheel up and down.

EZ Record (Step 2/3)
Record Method Setup

Which recording method would you prefer to use?

Motion Event Record (Recommended)

Continuous & Motion Event Record

Continuous Record

Motion Event Record means that the system will record when a Motion Event is detected. Generally, video quality is more important for Motion Event Recording than it is for Continuous Recording, so the system records at a higher quality for Motion Events.

Record Method Setup

- Select the desired recording mode from:
 - Motion Event Record (Recommended)
 - Continuous & Motion Event Record
 - Continuous Record

NOTE: You should understand each recording mode before setting the DVR's recording method.

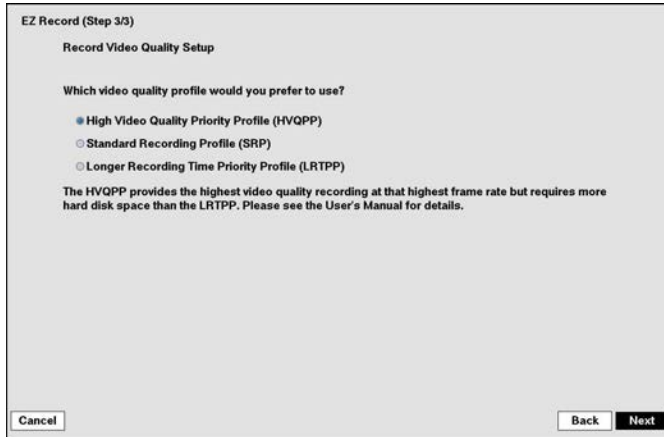

Record Video Quality Setup

- Select the desired video quality profile from:
 - Higher Video Quality Priority Profile
 - Standard Recording Profile
 - Longer Recording Time Priority Profile

NOTE: The higher quality setting requires more storage space.

The recording resolution will be set to Very High when selecting *High Video Quality Priority Profile*, High when selecting *Standard Recording Profile*, and Standard when selecting *Longer Recording Time Priority Profile*.

The recording quality and recording speed of each camera channel will be set as show below according to the *Record Method* and *Record Video Quality* you set.

	HVQPP*	SRP*	LRTPP*
Motion Event Record	Very High / 30 ips	High / 5 ips	Standard / 3 ips
Continuous & Motion Event Record	Very High / 30 ips (Time) Very High / 30 ips (Event)	High / 5 ips (Time) Very High / 30 ips (Event)	Standard / 3 ips (Time) High / 5 ips (Event)
Continuous Record	Very High / 30 ips	High / 5 ips	Standard / 3 ips

* Record Video Quality: HVQPP (High Video Quality Priority Profile), SRP (Standard Recording Profile), LRTPP (Longer Recording Time Priority Profile)



Select the Finish button to finish the EZ Record and select the Go to EZ Network button to start the EZ Network.

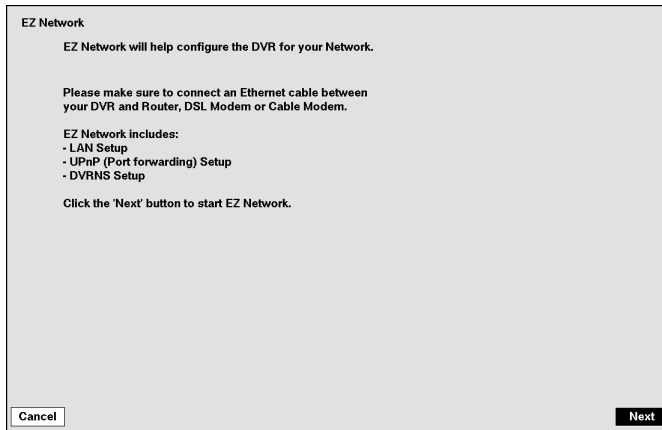

If you selected the Go to EZ Network, select the Next button to start the EZ Network.

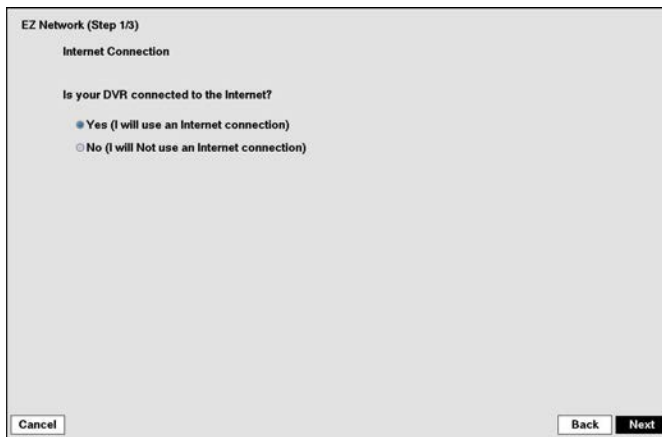

Internet Connection

Select whether or not your DVR is connected to the Internet.

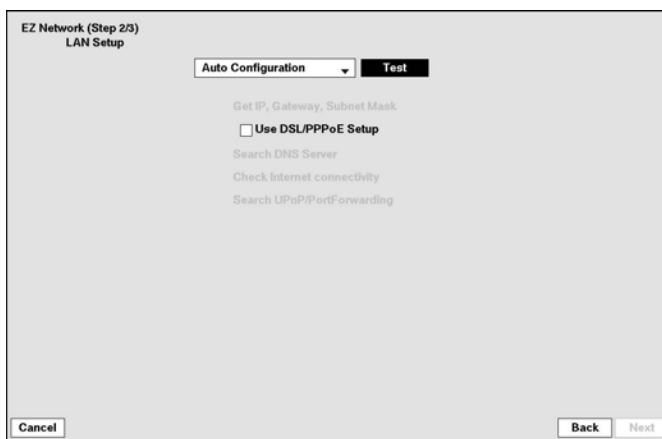

LAN Setup

Select between Auto Configuration and Manual Configuration for network configuration, and then select the Test button to test the network configuration you selected.

NOTE: Selecting *Auto Configuration* allows the DVR to automatically obtain LAN parameters (IP address, Gateway, Subnet Mask and DNS Server address). Selecting *Manual Configuration* allows you to set up LAN parameters manually.

The network configuration you set should be tested by selecting *Test*, otherwise the *Next* button will not be selected, and you cannot move to the next step.

- Use DSL/PPPoE Setup: Selecting the box allows you to set up the DSL network. Entering the ID and password for DSL connection is required.

EZ Network (Step 3/3)
DVRNS Setup

You need to name your DVR DVRNS to work.

Now enter the DVR name you created to access this DVR.
NO SPACES!

DVR Name Test

Cancel Back Next

DVRNS Setup

- DVR Name: Enter the DVR name to be registered on the DVRNS server.

NOTE: The DVR Name you entered should be checked by selecting *Test*, otherwise the DVRNS changes will not be saved.

When entering no name or a name already registered on the DVRNS server, an error message displays.

EZ Network

You have now completed your network setup.

Click 'Finish' to complete EZ Network

Cancel Finish

Select the *Finish* button to finish the EZ Setup.

Date/Time

Highlight Date/Time and press the  button, and the Date/Time setup screen appears.

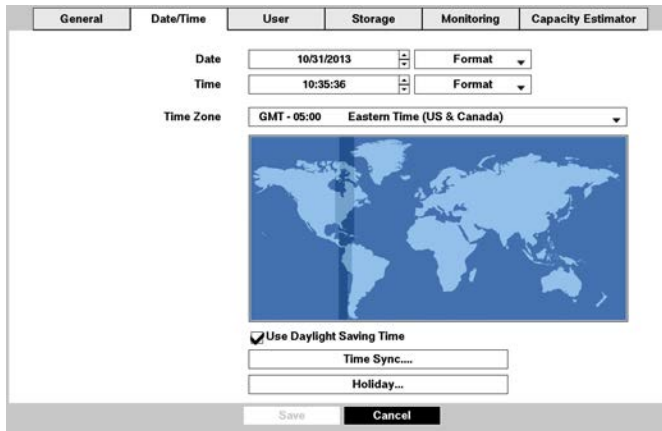











Figure 9 : System – Date/Time setup screen.



Highlight the first box beside **Date** and press the  button. The individual sections of the date will highlight. Use the Up and Down arrow buttons to change the number. Use the Left and Right arrow buttons to move between month, date and year. Once you have the correct date, press the  button.

Highlight the Format box beside **Date** and press the  button. Select from the three available date formats and press the  button to save your selected format.



Highlight the first box beside **Time** and press the  button. The individual sections of the time will highlight. Use the Up and Down arrow buttons to change the number. Use the Left and Right arrow buttons to move between hour, minutes and seconds. Once you have the correct time, press the  button.

Highlight the Format box beside **Time** and press the  button. Select from the three available time formats and press the  button to save your selected format.

NOTE: The clock will not start running until you have highlighted Save and pressed the  button.

Highlight the box beside **Time Zone** and press the  button. Select your time zone from the list and press the  button.

NOTE: The Time Zone can also be selected on the map below by pressing the Left and Right buttons or scrolling the mouse wheel up and down.

Highlight Use Daylight Saving Time and press the  button. Pressing the  button toggles between On and Off.

Highlighting Time Sync... and pressing the  button displays the Time Sync. screen. You can set up time synchronization between the DVR and standard time servers that are available in most time zones and countries, or between the DVR and another DVR.



Highlight the box beside **Automatic Sync.** and press the  button. This toggles between On and Off.

Highlight the box beside Time Server and press the button. A virtual keyboard appears that you can use to enter the IP address or domain name of the time server. Highlighting allows you to select your time server from a list of registered time servers.

NOTE: You can use the domain name instead of IP address if you already set up the DNS Server when setting up the Network – IP Address.

Highlight the box beside Interval and press the button. Set the time interval for synchronization from 30 minutes to 1 day at various time intervals.

Last Sync-Time displays the last time the DVR was synchronized with the time server.

Highlight Run as Server and press the button. Pressing the button toggles between On and Off. When it is On, the DVR you are setting up will run as a time server.

Highlighting Holiday... and pressing the button displays the Holiday screen.



You can set up holidays by highlighting + and pressing the button. The current date appears.

Highlight the month and day and change them by using the Up and Down arrow buttons. Press the button to add the date. Dates can be deleted by highlighting the beside the date and pressing the button.

NOTE: Holidays that do not fall on the same date each year should be updated once the current year's holiday has passed.

User

Highlight User and press the button. The User setup screen displays the authorized groups and users. You can add and delete groups and users. When adding a group, you can assign authority levels to the group.

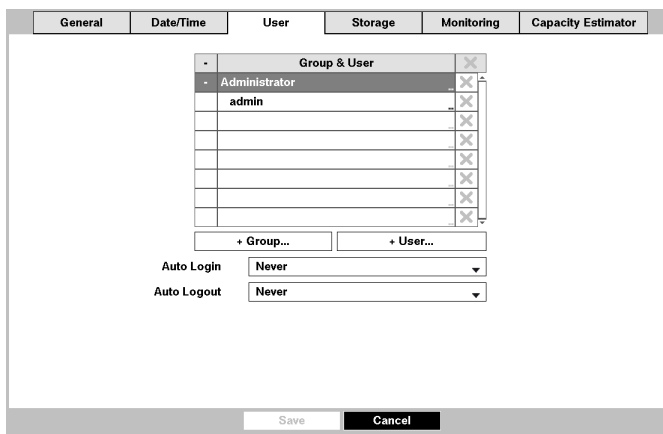







Figure 10 : System – User setup screen.

The +/- column is used to collapse and expand user groups. If there is a + or – in this column, it indicates the item is a Group Name. If there is a – in front of the Group Name, it indicates that the group has been “expanded” and all of the User Names within that group are displayed below the Group Name. If there is a + in front of the Group Name, it indicates that the group has been “collapsed” and all of the User Names within that group are hidden. To collapse or expand a group, highlight the +/- column in front of the desired group and press the button.

Highlighting a Group Name and pressing the button allows you to change the authority levels assigned to the group.



CAUTION: Write down the new password and save it in a secure place. If the password is forgotten, the unit must be reset using the *Factory Reset Button* and all data settings will be lost.

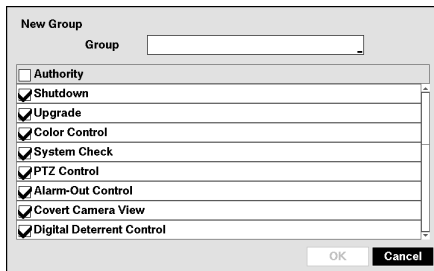

Highlighting a User Name and pressing the  button allows you to add or change the password assigned to that user. You can also change the group to which the user is assigned.

The  column can be used to delete a User Name or an entire Group. If the  is grayed out, that Group or User cannot be deleted. Highlight the  and press the  button. You will be asked to confirm that you want to delete the User or Group. To delete the User currently logged into the DVR on a local system or a PC running Speco Central, log the user out of the system first and then delete the user.

To add a Group, highlight the + Group... box and press the  button. A virtual keyboard appears allowing you to enter the Group name. You can use up to 15 characters including spaces in the group name. Enter the name and assign authority levels to the group.



Highlighting the Authority box and pressing the  button will toggle between all authority levels being turned On and Off. Highlighting the individual authority level boxes and pressing the  button will toggle between that authority level being turned On and Off. The authority levels that can be turned On and Off are:

- Shutdown – The user can shut the system down on a local system.
- Upgrade – The user can upgrade the software on a local system or a PC running Speco Central.
- Color Control – The user can control brightness, contrast, hue and saturation for cameras on a local system or a PC running Speco Central.
- System Check – The user can view the remote system status or check the remote system status as a batch process on a PC running Speco Central.
- PTZ Control – The user can control the PTZ camera on a local system or a PC running Speco Central.
- Alarm-Out Control – The user can reset the DVR's outputs including the internal buzzer during an alarm by pressing the  button on a local system or alarm-out control button on a PC running Speco Central.
- Covert Camera View – The user can view video from cameras set as Covert while in the Live Monitoring or Search mode on a local system or a PC running Speco Central.
- Digital Deterrent Control – The user can trigger the Digital Deterrent sound manually by selecting  (Digital Deterrent) in the Live Monitoring menu and Search menu on a local system.
- Search – The user can access the Search mode on a local system or a PC running Speco Central.
- Clip-Copy – The user can copy video clips on a local system or a PC running Speco Central.
- Setup – The user without Setup authority cannot establish any system settings excluding system shutdown and logout on a local system or a PC running Speco Central.
- System Time Change – The user can change the system date and time on a local system or a PC running Speco Central.
- Data Clear – The user can clear all video data or format disks on a local system or a PC running Speco Central.
- PTZ Setup – The user can establish all PTZ settings on a local system or a PC running Speco Central.
- Alarm-Out Setup – The user can establish all Alarm-Out settings on a local system or a PC running Speco Central.
- Covert Camera Setup – The user can establish all Covert Camera settings on a local system or a PC running Speco Central.
- Record Setup – The user can establish all Record settings on a local system or a PC running Speco Central.
- Digital Deterrent Setup – The user can establish all Digital Deterrent settings on a local system.
- Setup Import – The user can import saved DVR settings from a local system or a PC running Speco Central.
- Setup Export – The user can export the current DVR settings to a local system or a PC running Speco Central.
- VNC Setup – The user can establish all VNC settings on a local system or a PC running Speco Central.



To add a User, highlight the + User... box and press the  button. A virtual keyboard appears allowing you to enter the User Name. Enter the name and assign the User to a Group and password. You can use camera buttons 1 to 9 on the front panel to assign the password. The password can be up to 8 digits. You will be asked to confirm the password.

NOTE: In addition to using the front panel buttons or the infrared remote control, you can use the virtual keyboard to assign the password. To display the virtual keyboard click the  button using the mouse (not supplied).

Highlighting the box beside Auto Login allows you to select a User to be automatically logged in when the DVR is powered up. It can also be set to never automatically login a user.

Highlighting the box beside Auto Logout allows you to select from a list of times that the user will be automatically logged out. The options are: Never, 1 min., 3 min., 5 min., 10 min., 15 min., 20 min., 30 min. and 1 hr.

Storage

Highlight Storage and press the  button. The Storage setup screen appears and displays information about the DVR's storage devices.

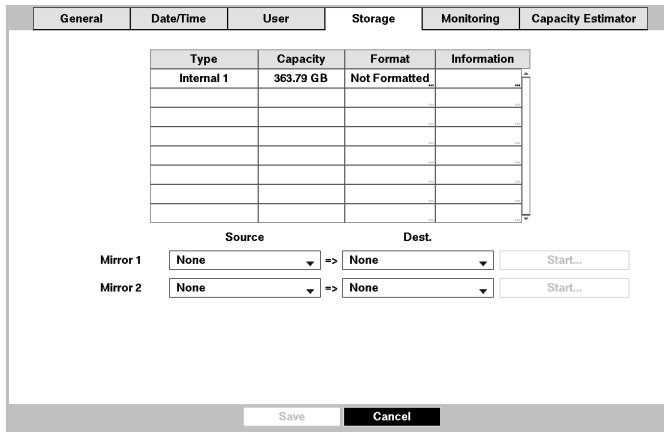



Figure 11 : System – Storage setup screen.

The information in the Type column describes the storage device.

The capacity of the storage device is displayed in the Capacity column.

The Format column displays whether the device is used for recording (Record), archiving (Archive) or not (Not Using). Not formatted indicates the device is not formatted.  indicates when the device has temporary space set aside so that video clips can be saved on a DVD RW.





Highlight the box in the Format column for the desired storage device and press the  button. You will be able to format the device for recording or archiving. When selecting Not Using from Use As and highlighting the Format button, the device will not be used for either recording or archiving. You can also set aside space to store temporary files for CD or DVD burning by selecting Partition – CD/DVD Burn.

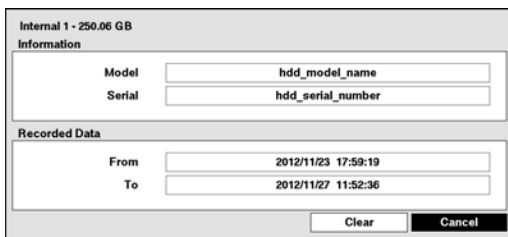

NOTE: The DVR does NOT support USB hard disk drives with a version lower than 2.0.

The Information column displays whether the device is being used or not. Other indicates the device has been used for another DVR.

Highlight the box in the Information column for the desired storage device and press the  button. You will be able to check the model name, serial number and the time information about recorded data.



If you want to erase recorded data on the selected device, highlight Clear and press the  button. You will be asked whether or not you want to delete the data.

If you want to use a USB hard disk drive, highlight Use and press the  button after connecting the device. Highlight Don't Use and press the  button if you want to stop using the device.

CAUTION: Do NOT disconnect the USB cable or the power from the device while copying video clips. If the USB cable is disconnected while copying video clips, archived data might be lost.

Highlight the boxes beside **MIRROR** and press the **[↔]** button. The DVR can be set up to mirror Source disks to designated Dest. (destination) disks selected from internal hard disk drives. Refer to the *Chapter 4 – Disk Mirroring* for further information on setting up disk mirroring.

Monitoring

Highlight **Monitoring** and press the **[↔]** button, and the Monitoring setup screen appears.

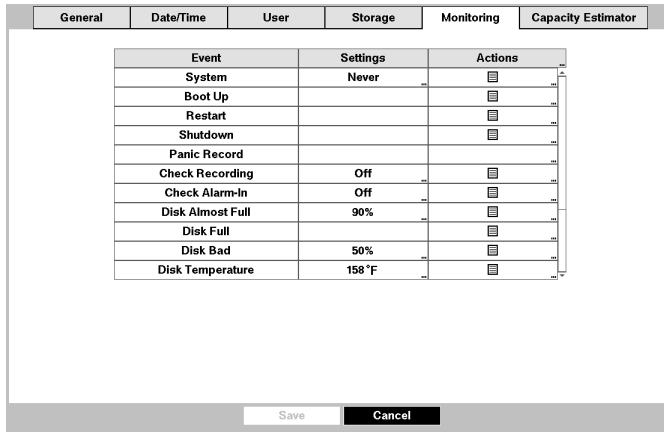

Figure 12 : System – Monitoring setup screen.

The DVR can be configured to run self-diagnostics and report the results.

Highlight the **Settings** box beside the desired event (System, Check Recording, Check Alarm-In, Disk Almost Full, Disk Bad, or Disk Temperature), and press the **[↔]** button.

Highlight the **Settings** box beside **System** and press the **[↔]** button. You can select the interval that you want the DVR to run self-diagnostics on the system. You can select from 1 hr. to 30 days or **Never**.

Highlight the **Settings** box beside **Check Recording** and press the **[↔]** button. The Check Recording screen appears.

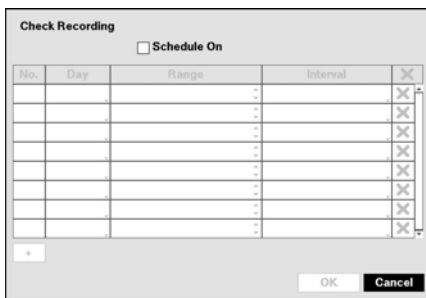

Highlighting **Schedule On** and pressing the **[↔]** button toggles On and Off. When set to On, you can select the day, time range and interval that you want the DVR to run self-diagnostics on the recorder. The **Interval** can be selectable from 1 min. to 7 days or **Never**. Highlight the **+** and press the **[↔]** button to add a schedule item. The **X** box allows you to delete a check recording schedule.

Highlight the **Settings** box beside **Check Alarm-In** and press the **[↔]** button. You can select the interval that you want the DVR to run self-diagnostics on Alarm Inputs. You can select from 1 hr. to 30 days or **Never**.

Highlight the **Settings** box beside **Disk Almost Full**, and press the **[↔]** button. Select the percentage level of disk usage at which you want the DVR to trigger an alert. Percentage levels range from 80% to 99%.

Highlight the **Settings** box beside **Disk Bad**, and press the **[↔]** button. Select percentage level of bad disk sectors at which you want the DVR to trigger an alert. Percentage levels range from 10% to 90%.

Highlight the **Settings** box beside **Disk Temperature**, and press the button. Select the temperature of hard disk drive at which you want the DVR to trigger an alert if the temperature exceeds the defined threshold. Refer to the hard disk drive manufacturer’s documentation for the correct temperature setting.

The DVR can be set to react to system events. Highlight the **Actions** box beside the desired event and press the button. System events can be associated with an Alarm-Out connector, sound the DVR’s internal buzzer, and/or notify a number of different devices.

NOTE: *Alarm-Out* action cannot be set to *System , Boot Up, Restart and Shutdown* events.

For the Notify action to work, the DVR should be registered in the Speco Central (Remote Administration System).

Capacity Estimator

Highlight Capacity Estimator and press the button, and the Capacity Estimator setup screen appears.

Figure 13 : System – Capacity Estimator setup screen.

The Capacity Estimator screen allows you to calculate the available record time of the DVR’s storage device. Set up the calculation conditions.

- Video Format: Select the video format: NTSC or PAL. (Local Camera Only)
- Number of Cameras: Select the number of cameras.
- Number of Audio-In: Select the number of audio inputs.
- Average Event Rate: Set the average event rate. (Network Camera Only)
- Quality: Set the recorded image quality.
- Resolution: Set the recorded image resolution.
- Frame Rate: Set the images per second for recording.
- Disk Capacity: Set the capacity of the storage device.
- Number of Cameras: Select the video format: NTSC or PAL.
- Quality: Select the number of cameras.
- Average Event Rate: Select the number of audio inputs.
- Number of Audio-In: Set the average event rate.
- Resolution: Set the recorded image quality.
- Frame Rate: Set the recorded image resolution.
- Frame Rate: Set the images per second for recording.
- Disk Capacity: Set the capacity of the storage device.

Estimated Recordable Time displays the estimated available record time.

NOTE: The estimated available record time can vary from the actual recording time.

Recording Setup

General

Highlight General and press the  button, and the General setup screen appears.

Figure 14 : Record – General setup screen.

Highlighting Recycle and pressing the  button toggles between On and Off. In the Recycle mode, the DVR records over the oldest video data once all available storage space has been used. When Recycle is turned off, the DVR stops recording once all available storage space has been used.

Highlight the Event Record Dwell box and set the length of time you would like to record for the associated event. You can set the dwell from 5 seconds to 15 minutes. Refer to *Event Actions* screen in this chapter for information regarding event recording.

The DVR can record up to four audio inputs. Highlighting Record Audio and pressing the  button toggles between On and Off.

Highlight the slide bar beside Auto Deletion, and use the Left and Right arrow buttons or Up and Down arrow buttons to adjust the length of time recorded data will be kept from 1 to 999 days. The DVR automatically deletes video recorded earlier than the user-defined period under three conditions: at midnight, whenever the system reboots or whenever the user changes the Auto Deletion settings. Selecting Never will disable the Auto Deletion function.

Highlight the slide bar beside Limit Time-Lapse Recording, and use the Left and Right arrow buttons to adjust the length of the maximum storage time for time-lapse recording from 1 to 99 days. The Limit Time-Lapse Recording feature will function when the storage device has enough space to record video data longer than the preset period. When this feature is On, the DVR records over the oldest “time-lapse” video once all available storage has been used in the Recycle mode, so more event video can be saved. Selecting Never will disable the Limit Time-Lapse Recording function.

NOTE: When the storage device does not have enough space to record video data longer than the preset Limit Time-Lapse Recording period, the DVR records over the oldest video data (time-lapse or event video) as it would in the Recycle mode even if this feature is turned On.

The maximum storage time is only an estimate because the amount of space required to store video varies depending on many factors such as motion and image complexity.

CAUTION: When more than one disk is installed in the unit, the DVR records video on the disks sequentially based on time. And these sequentially recorded videos have the advantage that you can search recorded video easily even though a disk is removed from the unit. However, video recorded in the same time range might be saved on different disks by channel and by the type of recording mode. Once the Limit Time-Lapse Recording is set to On, the DVR will maintain this recording limitation even after disabling the function. If you want the DVR to record video on the disks sequentially based on time again, you must format all disks that are currently used for recording.

Highlighting Use Panic Recording and pressing the [Enter] button toggles between On and Off.

Highlight the Panic Recording – Duration box and set the duration of panic recording. Panic recording will stop automatically after the preset duration as long as [Panic] (Panic) in the Live Monitoring menu is not selected to stop the panic recording. You can set the dwell from 5 minutes to 1 hour. Select No Limit if you want to stop panic recording manually.

Highlighting the Panic Recording – ips and pressing the [Enter] button allows you to set the images per second for Panic recording. You can select from 1.00 to 30.00 ips (25.00 ips PAL).

Highlighting the Panic Recording – Quality and pressing the [Enter] button allows you to set the recorded image quality for Panic recording. You can select from: Very High, High, Standard and Basic.

Highlighting the Panic Recording – Resolution and pressing the [Enter] button allows you to set the recorded image resolution for Panic recording. You can select from: Very High (4CIF/960H), High (2CIF/H960H) and Standard (CIF/Q960H).

Schedule

Highlight Schedule and press the [Enter] button, and the Schedule setup screen appears.

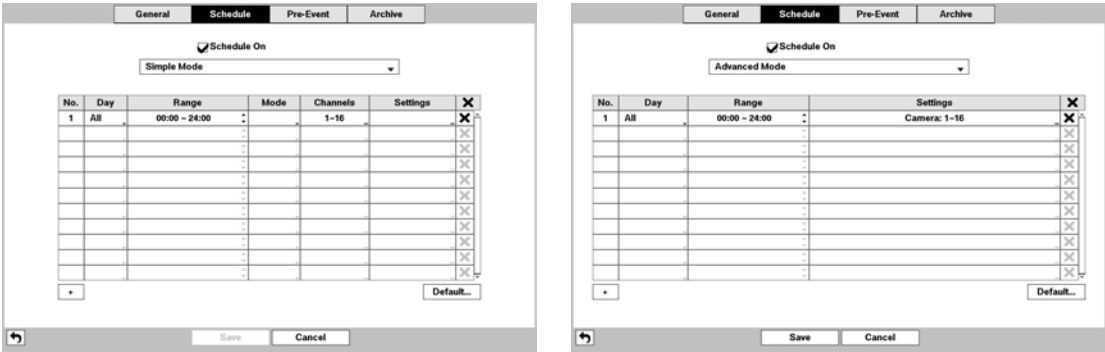

< Simple Mode >

< Advanced Mode >

Figure 15 : Record – Schedule setup screen.

You can program the DVR to record only during certain times based on time, day of the week, and holidays. The smallest time segment you can use is 15 minutes.

Highlighting Schedule On and pressing the [Enter] button toggles between On and Off. In the Schedule On mode, the DVR records video based on the schedule established in the Schedule screen. When turning Schedule recording Off, you will be asked to confirm your decision, and [Panic] displays at the top-left corner of each camera screen. Panic recording will function even when Schedule is turned off. [Panic] displays during panic recording.

Highlight the Schedule Mode box and press the [Enter] button. You can select between Simple Mode and Advanced Mode. Selecting Advanced Mode allows you to set up individual recording schedule for each event.

NOTE: Changing the schedule mode will reset all event and action statuses.

Highlight the + and press the [Enter] button to add a schedule item.

Highlight the box under the Day heading and press the button to change the days that the scheduled recording will take place. Choose from: Sun, Mon, Tue, Wed, Thu, Fri, Sat, M-F, Hol and All.

Highlight the box under the Range heading and press the button to change the time range that the scheduled recording will take place. The smallest time segment you can use is 15 minutes.

Highlight the box under the Mode heading and press the button to change the recording mode that will be used. Choose from: No Record, Time, Event and Time & Event. (Simple Mode Only)

When the DVR is in the No Record mode, it will not record during the preset day and time range as long as (Panic) in the Live Monitoring menu is not selected. Use the No Record mode when you do NOT want the DVR to record during certain times.

When the DVR is in the Time mode, the icon displays at the top-left corner of the screen. The DVR will record and displays the icon at the top-left corner of the screen during the scheduled times.

When the DVR is in the Event mode, the red icon displays at the top-left corner of the screen. The DVR will record and displays the icon at the top-left corner of the screen when any event occurs. When the DVR is in the Pre-Event recording mode, the yellow icon displays when there is no event, and the DVR is not recording. When the DVR is in the Pre-Event mode, the red and display when any event occurs and the DVR starts recording.

When the DVR is in the Time & Event mode, the DVR will follow the Time settings and the icon displays at the top-left corner of the screen. The DVR follows the Event settings and the icon displays.

Highlight the box under the Channels heading and press the button to select which cameras will be recorded. (Simple Mode Only)

Highlight the box under the Settings heading and press the button to define the recording settings.

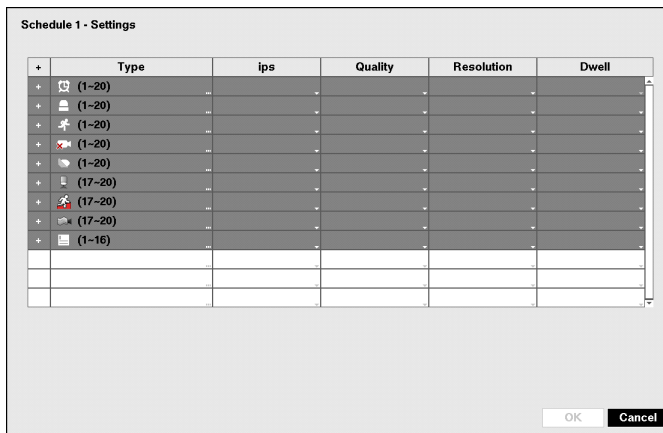

Figure 16 : Schedule – Settings (Advanced Mode) setup screen.

You can set the ips, Quality and Resolution (ips, Quality, Resolution and Dwell for Advanced Mode setup) of the recording for any modes you set up in the Mode column. If you do not set the ips, Quality, Resolution and Dwell in the Settings column, the DVR will follow the default settings. See below for details.

NOTE: The recording speed (ips), quality and resolution used by the network camera are the settings you set in the camera not those set in the DVR.

Descriptions of the Record icons in the Type column are as follows:

- Time-lapse (Time) Alarm-In Motion Video Loss
- Video Blind Audio (Network Devices Only) Trip-Zone (Network Devices Only)
- Tampering (Network Devices Only) Text-In

Channels that are not defined will use the setting values of the previous schedule item.

NOTE: When multiple events are detected at the same time from a specific channel, the DVR will record event video with the high setting values if the ips, Quality, Resolution and Dwell values of events are different from each other. However, the ips will be reset to the supported maximum value when the ips, Quality, Resolution and Dwell are all set to the highest value. (Advanced Mode Only).

When the ips, quality and resolution for the network video transmitter you set in the DVR are higher than those you set in the network video transmitter, the DVR will record video using the settings in the network video transmitter.

Depending on network conditions, the ips, quality and resolution for the network video transmitter (ips for the network camera) may not be attainable.

For network devices using the ONVIF™ Conformance Protocol, the DVR records using the profile settings designated in the DVR preset profiles. You can designate which profile to use for recording when setting up the network device. Refer to *Camera – Network Camera* setup screen in this chapter and *Appendix – Remote Setup of Network Devices* for further information on setting up the network device.

When recording video from network devices, the archiving speed might decrease.

Highlight the box under the **X** heading and press the  button to delete the recording settings. You will be asked to confirm that you want to delete the settings.

Highlight Default... and press the  button. The Default screen appears.

Default				
Mode	ips	Quality	Resolution	Dwell
Time	25.00 ips	Standard	Standard (CIF/Q960H)	
Event	25.00 ips	High	High (2CIF/H960H)	5 sec.



Highlighting boxes under ips and pressing the  button allows you to set the images per second for Time and Event recording. You can select from 1.00 to 30.00 ips (25.00 ips PAL).

Highlighting boxes under Quality and pressing the  button allows you to set the recorded image quality for Time and Event recording. You can select from: Very High, High, Standard and Basic.

Highlighting boxes under Resolution and pressing the  button allows you to set the recorded image resolution for Time and Event recording. You can select from: Very High (4CIF/960H), High (2CIF/H960H) and Standard (CIF/Q960H).

Highlighting boxes under Dwell and pressing the  button allows you to set the length of time you would like to record for the associated event. (Advanced Mode Only)

Pre-Event

Highlight Pre-Event and press the  button, and the Pre-Event setup screen appears. If you do not have Event set up in the Record Schedule, a message will display alerting you to this fact.

General					Schedule					Pre-Event					Archive				
No.	ips	Quality	Resolution	Dwell															
<input type="checkbox"/> 1. CAM1	25.00 ips	Standard	Standard (CIF/Q960H)	00 min. 05 sec.															
<input type="checkbox"/> 2. CAM2	25.00 ips	Standard	Standard (CIF/Q960H)	00 min. 05 sec.															
<input type="checkbox"/> 3. CAM3	25.00 ips	Standard	Standard (CIF/Q960H)	00 min. 05 sec.															
<input type="checkbox"/> 4. CAM4	25.00 ips	Standard	Standard (CIF/Q960H)	00 min. 05 sec.															
<input type="checkbox"/> 5. CAM5	25.00 ips	Standard	Standard (CIF/Q960H)	00 min. 05 sec.															
<input type="checkbox"/> 6. CAM6	25.00 ips	Standard	Standard (CIF/Q960H)	00 min. 05 sec.															
<input type="checkbox"/> 7. CAM7	25.00 ips	Standard	Standard (CIF/Q960H)	00 min. 05 sec.															
<input type="checkbox"/> 8. CAM8	25.00 ips	Standard	Standard (CIF/Q960H)	00 min. 05 sec.															
<input type="checkbox"/> 9. CAM9	25.00 ips	Standard	Standard (CIF/Q960H)	00 min. 05 sec.															
<input type="checkbox"/> 10. CAM10	25.00 ips	Standard	Standard (CIF/Q960H)	00 min. 05 sec.															
<input type="checkbox"/> 11. CAM11	25.00 ips	Standard	Standard (CIF/Q960H)	00 min. 05 sec.															
<input type="checkbox"/> 12. CAM12	25.00 ips	Standard	Standard (CIF/Q960H)	00 min. 05 sec.															



Figure 17 : Record – Pre-Event setup screen.

When the DVR is in the Event Record mode it is possible to have it record images before the event occurs. The Pre-Event screen allows you to define how to handle pre-event recording.

You can turn individual cameras On or Off for pre-event recording. The image speed can be set from 1.00 to 30.00 ips (25.00 ips PAL), image quality can be selectable from Very High, High, Standard and Basic, and image resolution can be selectable from Very High (4CIF/960H), High (2CIF/H960H) and Standard (CIF/Q960H).

NOTE: Depending on network conditions, the ips, quality and resolution for the network video transmitter (ips for the network camera) you set may not be attainable.

You can set the amount of time to record prior to the event by adjusting the Dwell. You can set the Dwell from 5 seconds to 30 minutes. The longer the dwell set, the fewer maximum ips can be set.

NOTE: Depending on the ips, quality and resolution of recorded video, the pre-event Dwell you set may not be attainable. (Network Camera Only)

When the DVR is in the Time or Time & Event mode, it ignores the pre-event settings and follows the time settings.

Archive

Highlight Archive and press the  button, and the Archive setup screen appears.



Day	Range
<input checked="" type="checkbox"/> Sun	00:00 - 24:00
<input checked="" type="checkbox"/> Mon	00:00 - 24:00
<input checked="" type="checkbox"/> Tue	00:00 - 24:00
<input checked="" type="checkbox"/> Wed	00:00 - 24:00
<input checked="" type="checkbox"/> Thu	00:00 - 24:00
<input checked="" type="checkbox"/> Fri	00:00 - 24:00
<input checked="" type="checkbox"/> Sat	00:00 - 24:00

Figure 18 : Record – Archive setup screen.

Highlight Archive On and press the  button to toggle between On and Off.

NOTE: If you have not set up a storage device for archiving, a message appears notifying you of this.

Select the Days and Time Range you want archived.

You can accept the Archive Data Range by leaving the default checkmarks in the Last Archived and Continue boxes. If you wish to enter specific times and dates in From and To, toggle the checkmarks Off and then enter the time and date.

Highlight Recycle and press the  button to toggle between On and Off. When Recycle is On and the storage device is full, the newest archived video data will overwrite the oldest archived data. When Recycle is Off, the DVR will stop archiving video data until more space is made available.

CAUTION: When the Recycle is On, changing the start date and time for archiving will delete all archived data after the changed start date and time.

Highlight Summary Archive and press the  button to toggle between On and Off. When Summary Archive is On, the DVR does not archive the entire recorded video, but instead archives 1 or 2 ips from each channel. This allows the DVR to archive more video and increases archive speed too.

NOTE: The archiving speed might be slower than the recording speed when a large quantity of recorded data is being archived. In this case, the oldest data can be overwritten by the latest data being recorded. To prevent data you want to keep from being overwritten, use the Summary Archive function, or set the recorded image quality to Standard during the archiving process.

Event Setup

Motion

Highlight Motion and press the  button, and the Motion setup screen appears. (Local Cameras Only)

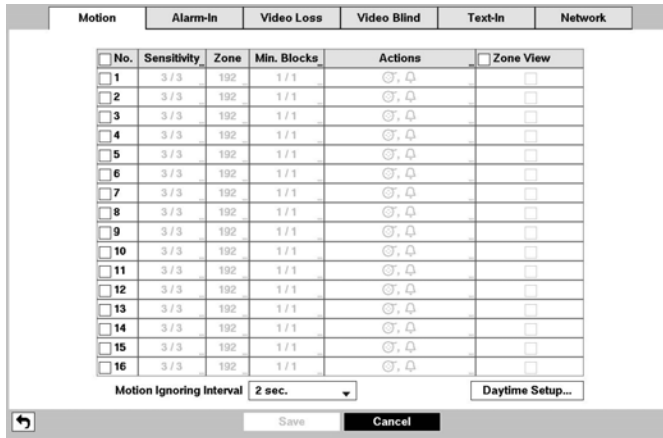
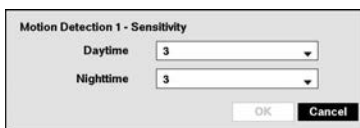



Figure 19 : Event – Motion setup screen.

Your DVR has built-in video motion detection. Video motion detection can be turned On or Off for each camera.



Highlighting the box under the Sensitivity heading and pressing the  button allows you to adjust the DVR’s sensitivity to motion for Daytime and Nighttime independently. There are five settings with 1 being the least sensitive and 5 being the most sensitive.

You can define the area of the image where you want to detect motion; e.g., a doorway. Highlight the box under the Zone heading, and press the  button. The Motion Detection Zone screen displays.

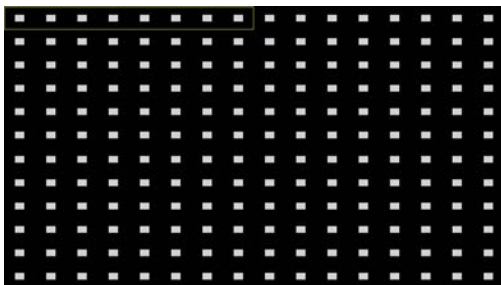

The Motion Detection Zone screen is laid over the video for the selected camera. You can set up motion detection zones by selecting or clearing blocks.

NOTE: You can set up motion zones one block at a time in groups of 8 individual block groups. A block group is positioned within the image area using the Up and Down arrow buttons, and individual blocks within the block groups are selected or cleared using the camera buttons.

Press the  button to display the menu screen. The menu on the setup screen has the following functions:

- Select
- Clear
- Reverse
- Select All
- Clear All
- Reverse All
- OK
- Cancel

Select — Activates highlighted blocks to detect motion.
 Clear — Deactivates highlighted blocks so that they will not detect motion.
 Reverse — Activates inactive highlighted blocks and deactivates active highlighted blocks.
 Select All — Activates all blocks to detect motion.
 Clear All — Deactivates all blocks so that they will not detect motion.
 Reverse All — Activates inactive blocks and deactivates active blocks.
 OK — Accepts changes and closes Zone setup.
 Cancel — Exits Zone setup without saving changes.

You can adjust the minimum number of detection blocks that must be activated to trigger a motion alarm. Highlighting the box under the **Min. Blocks** heading and pressing the button allows you to adjust the minimum number of detection blocks for Daytime and Nighttime independently. Smaller numbers provide greater sensitivity because fewer detection blocks must be activated.

Highlight the box under the **ACTIONS** and press the button. The DVR can be set to react to motion detection differently for each camera. Each camera can be associated with another camera, trigger an Alarm-Out connector, sound the DVR's internal buzzer, notify a number of different devices, move PTZ cameras to preset positions, display a camera on a SPOT monitor, and/or trigger the Digital Deterrent sound.

Turning **Zone View On** will allow you to observe how the DVR is reacting to motion. When in the motion viewing mode, the detection zone of video will be displayed. Any detected motion within the zone will be displayed in red.

You can control excessive event logging and remote notification of motions detected after the motion dwell time by adjusting the motion ignoring dwell intervals. Highlight the box beside **Motion Ignoring Interval** and press the button. A list of intervals ranging from 1 to 5 seconds or **Never** appears. The DVR will not log and notify motion events occurred during the preset interval range.

NOTE: The record action for motion events will not be affected by the Motion Ignoring function.

Highlighting **Daytime Setup** and pressing the button allows you to set up the Daytime range.

Highlight the box beside **Daytime** and press the button. Use the Up and Down arrow buttons to set the Daytime range. The DVR will consider the remaining time range as the Nighttime.

Alarm-In

Highlight **Alarm-In** and press the button, and the Alarm-In setup screen appears. (Local Cameras Only)

No.	Title	Type	Actions
<input type="checkbox"/> 1		NC	
<input type="checkbox"/> 2		NC	
<input type="checkbox"/> 3		NC	
<input type="checkbox"/> 4		NC	
<input type="checkbox"/> 5		NC	
<input type="checkbox"/> 6		NC	
<input type="checkbox"/> 7		NC	
<input type="checkbox"/> 8		NC	
<input type="checkbox"/> 9		NC	
<input type="checkbox"/> 10		NC	
<input type="checkbox"/> 11		NC	
<input type="checkbox"/> 12		NC	
<input type="checkbox"/> 13		NC	
<input type="checkbox"/> 14		NC	
<input type="checkbox"/> 15		NC	
<input type="checkbox"/> 16		NC	

Panic Record:

Save Cancel

Figure 20 : Event – Alarm-In setup screen.

The alarm terminal strip on the back of the DVR has inputs associated with each alarm. You can set up each input on the Alarm-In screen. You can turn each input On or Off by highlighting the alarm number and pressing the **↵** button.

Each input can be given a title. Highlight the desired Title box and press the **↵** button. A virtual keyboard appears allowing you to enter a title name.

Each input can be set as NO (normally open) or NC (normally closed).

Highlight the box under the Actions and press the **↵** button. You can set the actions the DVR will take whenever it senses an input on one of its alarm input connectors. Alarm input can be associated with cameras, trigger an Alarm-Out connector, sound the DVR's internal buzzer, notify a number of different devices, move PTZ cameras to preset positions, display a camera on a SPOT monitor, and/or trigger the Digital Deterrent sound.

You can set up the DVR to start panic recording whenever it senses an input on one of its alarm input connectors. Highlight the box beside Panic Record and press the **↵** button. A list of Alarm Inputs appears, and you can select which alarm input you want associated with panic recording. The DVR will continue panic recording until an input on the selected alarm input is released as long as **Panic** in the Live Monitoring menu is not selected to stop the panic recording.

Video Loss

Highlight Video Loss and press the **↵** button, and the Video Loss setup screen appears. (Local Cameras Only)

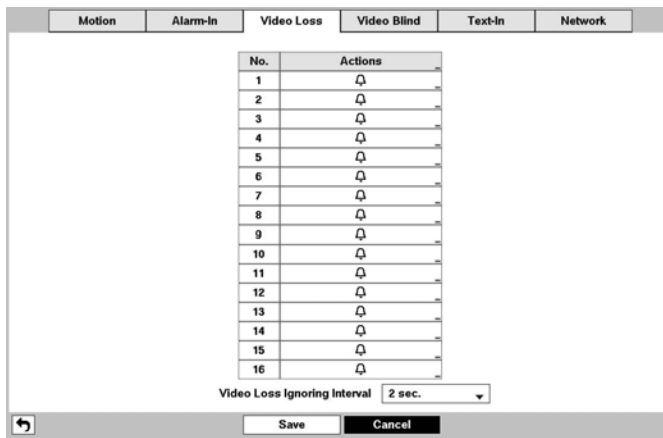



Figure 21 : Event – Video Loss setup screen.

Highlight the box under the Actions and press the **↵** button. The DVR can be set to react to video loss differently for each camera. Each camera can be associated with another camera, trigger an Alarm-Out connector, sound the DVR's internal buzzer, notify a number of different devices, move PTZ cameras to preset positions, and/or display a camera on a SPOT monitor.

Highlighting the box beside Video Loss Ignoring Interval and pressing the **↵** button allows you to set the duration of a signal loss before the DVR will report a Video Loss. The DVR will not consider any signal loss from a camera to be a Video Loss if the detected signal loss is shorter than the preset interval.

Video Blind

Highlight Video Blind and press the  button, and the Video Blind setup screen appears. The DVR checks to see if anything is blinding a camera. (Local Cameras Only)

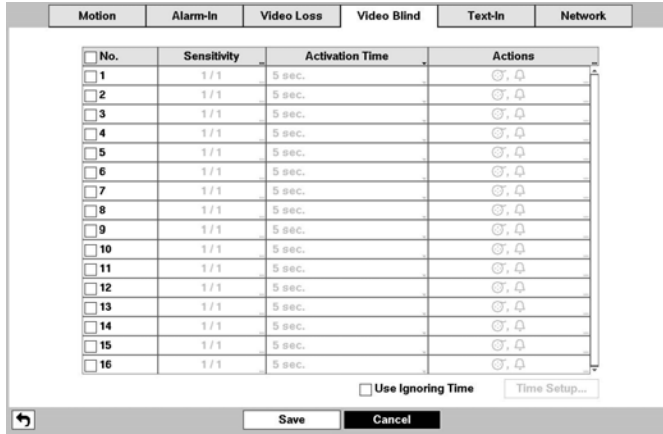

No.	Sensitivity	Activation Time	Actions
<input type="checkbox"/> 1	1/1	5 sec.	
<input type="checkbox"/> 2	1/1	5 sec.	
<input type="checkbox"/> 3	1/1	5 sec.	
<input type="checkbox"/> 4	1/1	5 sec.	
<input type="checkbox"/> 5	1/1	5 sec.	
<input type="checkbox"/> 6	1/1	5 sec.	
<input type="checkbox"/> 7	1/1	5 sec.	
<input type="checkbox"/> 8	1/1	5 sec.	
<input type="checkbox"/> 9	1/1	5 sec.	
<input type="checkbox"/> 10	1/1	5 sec.	
<input type="checkbox"/> 11	1/1	5 sec.	
<input type="checkbox"/> 12	1/1	5 sec.	
<input type="checkbox"/> 13	1/1	5 sec.	
<input type="checkbox"/> 14	1/1	5 sec.	
<input type="checkbox"/> 15	1/1	5 sec.	
<input type="checkbox"/> 16	1/1	5 sec.	

Use Ignoring Time Time Setup...



 Save Cancel

Figure 22 : Event – Video Blind setup screen.

You can turn individual cameras On or Off for video blind detection by highlighting the camera number and pressing the  button.



Video Blind 1 - Settings

Black  1

White  1



OK Cancel

Highlighting the box under the Sensitivity heading allows you to adjust the DVR's sensitivity to video blind for Black and White independently from 0 and 1 (least sensitive) to 10 (most sensitive).

NOTE: Video blind might NOT be detected for a camera with a very noisy image especially when set for low sensitivity values.

Highlighting the box under the Activation Time heading allows you to set the duration before the DVR will report a Video Blind. The DVR will not consider any blinded camera to be a Video Blind if the detected blindness is less than the Activation Time set on this screen.

Highlight the box under the ACTIONS and press the  button. The DVR can be set to react to video blind differently for each camera. Each camera can be associated with another camera, trigger an Alarm-Out connector, sound the DVR's internal buzzer, notify a number of different devices, move PTZ cameras to preset positions, and/or display a camera on a SPOT monitor.

Highlight Use Ignoring Time and press the  button to toggle between On and Off. When set to On, the DVR will ignore video blind events occurred during the preset period. Highlighting Time Setup and press the  button allows you to set up event ignoring time.

Text-In

Highlight Text-In and press the  button, and the Text-In setup screen appears. (Local Cameras Only)

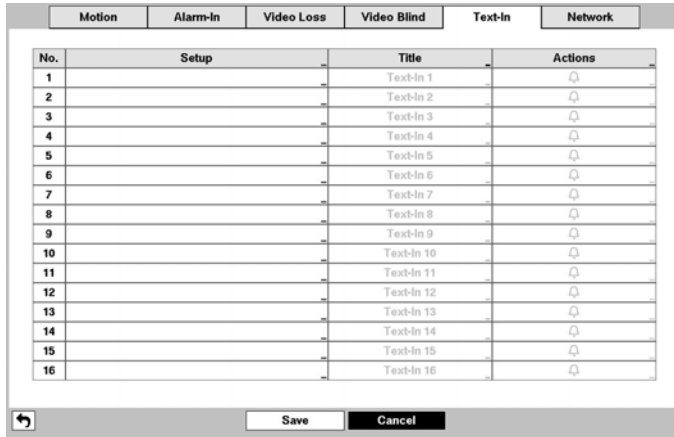

Figure 23 : Event – Text-In setup screen.

The DVR can be set to react to text input from devices such as ATMs (Automated Teller Machines) and POS (Point of Sale; i.e., cash registers). This screen allows you to configure the DVR for each text-in device.

Highlight the box under the Setup heading, and press the button. Selecting the Setup heading changes all the parameters excluding Port settings of all the text input channels.

NOTE: The system performance might be affected when a large quantity of text inputs are detected from several channels at the same time.

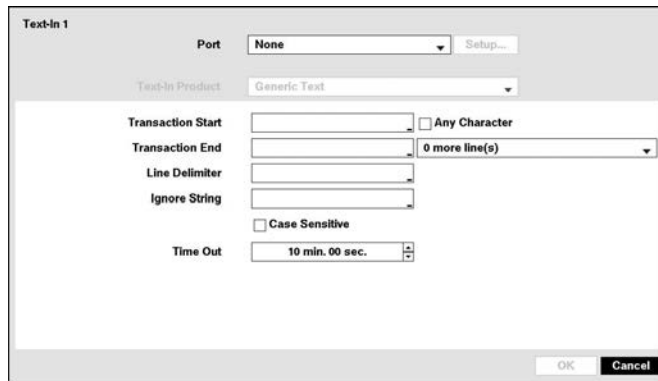

Figure 24 : Text-In Device screen.

Highlight the box beside Port, and press the button. Select from None, RS232, RS485, USB-Serial (1~8) and LAN (1~16).

NOTE: If you have set the Port as None, you will not be able to make any changes to the screen.
 When using the USB to serial text-in device, do NOT remove the USB cable from the port while the system is running.

Highlight Setup..., and press the button. Use the ATM or POS manufacturer’s recommended settings when configuring the RS232, RS485, USB-Serial or LAN ports.

Highlight the box beside Text-In Product, and press the button. Select your device from the list.

NOTE: The following description is for a Generic Text Device. The screen changes for different types of text input devices, and there will be different parameter boxes for you to enter information.

Highlight the box beside **Transaction Start**, and press the  button. Use the virtual keyboard to enter the Transaction Start string. Refer to the device manufacturer's documentation for the text string that the device first sends when a transaction starts.

If you want the DVR to react to any character sent from the text input device, you will want to turn **On Any Character**. Highlight **Any Character**, and press the  button to toggle between On and Off.

NOTE: If Any Character is turned On, you will not be able to enter any text in the Transaction Start box.

Highlight the box beside **Transaction End**, and press the  button. Use the virtual keyboard to enter the Transaction End string. Refer to the device manufacturer's documentation for the text string that the device sends when a transaction ends.

Highlight the **more line(s)** box, and press the  button. Select the number of additional lines of text that you want the DVR to record. You can choose from 0 to 10.

Highlight the box beside **Line Delimiter**, and press the  button. Use the virtual keyboard to enter the character(s) that the device uses to indicate the end of a line. Special characters can be created using ^ and a capital letter; e.g., ^J for NL (New Line), ^M for CR (Carriage Return). Refer to the device manufacturer's documentation for Line Delimiter character(s).

Highlight the box beside **Ignore String**, and press the  button. Use the virtual keyboard to enter any strings of text that you want the DVR to ignore. Refer to the device manufacturer's documentation for text strings that the device sends during transactions, so you will know which ones you do not want recorded.

Highlight the **Case Sensitive** box, and press the  button to toggle between On and Off. Refer to the device manufacturer's documentation to determine if the text strings are Case Sensitive. If the device distinguishes between upper and lower case letters, make certain the **Case Sensitive** box is turned On.

Highlight the box beside **Time Out**, and press the  button. Set the length of time to wait for the new text string. The DVR will consider a transaction complete if no new text strings are entered between the last text input and the dwell time out. You can adjust the Time Out dwell from 5 seconds to 15 minutes.

Highlight the box under the **ACTIONS** and press the  button. The DVR can be set to react to text input. Text input can be associated with cameras, trigger an Alarm-Out connector, sound the DVR's internal buzzer, notify a number of different devices, move PTZ cameras to preset positions, and/or display a camera on a SPOT monitor.

Network

Highlight **Network** and press the  button, and the Network setup screen appears. (Network Devices Only)

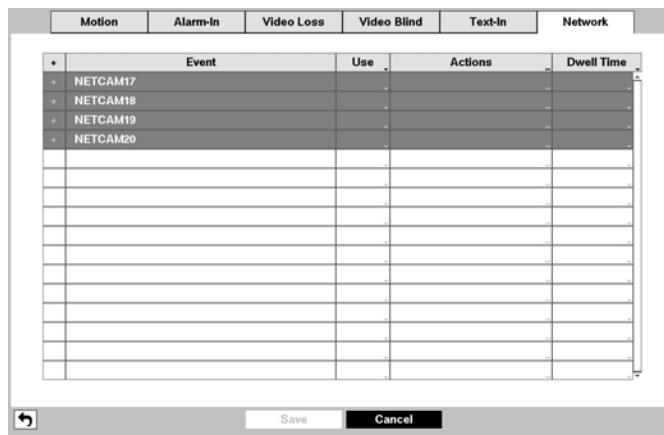





Figure 25 : Event – Network setup screen.

Highlighting the box under the **Event** and pressing the  button displays events that occurred on the network device channel that you selected.

NOTE: Displaying events is supported when the network device is networked with the DVR.

Highlighting the box under the Use and pressing the  button turns each selected event On and Off.

Highlighting the box under the Actions and pressing the  button selects how the DVR reacts to network devices events. The network devices events can be associated with cameras, trigger an Alarm-Out connector, sound the DVR's internal buzzer, notify a number of different devices, move PTZ cameras to preset positions, and/or display associated local cameras on a SPOT monitor.

NOTE: For the event detection and action to work, the event-related settings for network devices should set properly.

Highlighting the box under the Dwell Time and pressing the  button allows you to set the dwell time of network devices events. Dwell times range from 1 second to 15 seconds or Not Using.

Network Setup

General

Highlight General and press the  button, and the General setup screen displays.

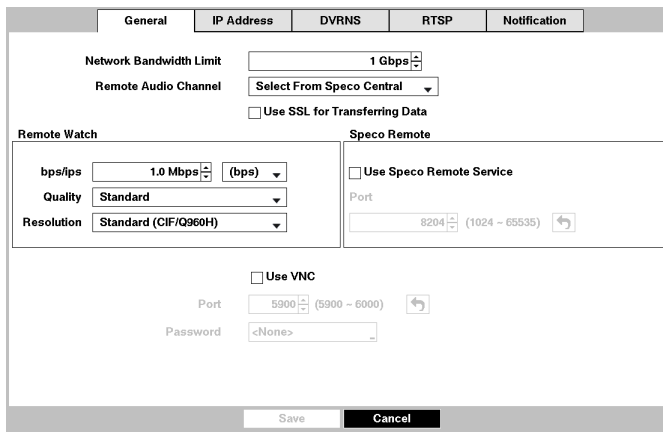



Figure 26 : Network – General setup screen.

You can limit the network bandwidth settings so that system does not consume too much network bandwidth. Highlight the box beside Network Bandwidth Limit and press the Up and Down arrow buttons to set the desired maximum bandwidth from 50Kbps to 1Gbps.

NOTE: When limiting the network bandwidth, the remote watch image on the PC running Speco Central or Speco Remote might not be displayed properly.

The DVR supports two-way audio communication between a local system and a PC running Speco Central. Highlighting the box beside Remote Audio Channel and pressing the  button allows you to select the audio channel that sends audio to the remote site. Selecting Select From Speco Central will send audio of the channel selected from Speco Central.

NOTE: Depending on network conditions, audio might be interrupted or out of synchronization during transmission.



Highlight Use SSL for Transferring Data and press the  button to toggle between On and Off. When it is On, the security of data except video and audio transmitted for remote monitoring or remote recording can be enhanced by using the SSL (Secure Sockets Layer) authentication. When using the SSL function, the DVR cannot be connected with a remote program or a network keyboard which does not support the SSL function.



CAUTION: The remote connection will be disconnected temporarily after changing the SSL settings.

NOTE: This product includes software developed by the OpenSSL Project for use in the OpenSSL Toolkit (<http://www.openssl.org/>).

Highlight the first box beside Remote Watch – bps/ips. Press the Up and Down arrow buttons to set the Transfer Speed from 50Kbps to 1Gbps.

Highlight the second box beside Remote Watch – bps/ips. You can select the unit of measure for the transfer speed between: bps and ips. Press the  button to set the transfer speed.

Highlight the box beside Remote Watch – Quality and press the  button. You can select the Quality from: Very High, High, Standard and Basic. Press the  button to set the Quality.

Highlight the box beside Remote Watch – Resolution and press the  button. You can select the Resolution from: High (2CIF/H960H) and Standard (CIF/Q960H). Press the  button to set the Resolution.

NOTE: The higher Quality and Resolution settings require higher Transfer Speed settings. The transfer speed you set is the maximum speed. Depending on the network environment, this speed may not be achieved.

Highlight Speco Remote – Use Speco Remote Service and press the  button to toggle between On and Off. See *Appendix – Speco Remote* for detailed descriptions of the Speco Remote service.

Highlight the box beside Speco Remote – Port and press the  button. Set the port number used when accessing Speco Remote by using the Up and Down arrow buttons to increase or decrease the numbers.

Highlight Use VNC (Virtual Network Computing) and press the  button to toggle between On and Off. You will be able to change the settings if Use VNC is enabled.



NOTE: VNC service allows you to access the DVR and control it remotely using a PC or mobile devices via Ethernet.

Highlight the box beside PORT and press the  button. Set the port number of the VNC server obtained from your system administrator.

Highlight the box beside Password and press the  button. A virtual keyboard appears allowing you to enter the password for VNC connection.

NOTE: Up to three users at a time can access a DVR remotely via VNC service.

When controlling the DVR remotely using a keyboard, shortcut keys perform the following functions as described below:

Key	Function
“←” or “h”	Pressing the “←” or “h” key moves to the left in the menu. It is the same as pressing the Left arrow button on the front panel.
“→” or “i”	Pressing the “→” or “i” key moves to the right in the menu. It is the same as pressing the Right arrow buttons on the front panel.
“↑” or “k”	Pressing the “↑” or “k” key moves up in the menu. It is the same as pressing the Up arrow button on the front panel.
“↓” or “j”	Pressing the “↓” or “j” key moves down in the menu. It is the same as pressing the Down arrow button on the front panel.
“m” or “  (Windows)	Pressing the “m” or “  ” key displays the Live Monitoring menu or Search menu on the screen. It is the same as pressing the MENU button on the front panel.
“Enter” or “Return”	Pressing the “Enter” or “Return” key selects the highlighted item or completes an entry that you have made during system setup. It is the same as pressing the  (Enter) button on the front panel.
“d” or “PageUp” or “PageDown”	Pressing the “d” or “PageUp” or “PageDown” key toggles between different display formats. It is the same as pressing the MODE button on the front panel.
“c” or “Home”	Pressing the “c” or “Home” key allows you to copy video clips. It is the same as pressing the COPY button on the front panel.
“F5”	Pressing the “F5” key refreshes the current VNC screen.

IP Address

Highlight IP Address and press the , and the IP Address setup screen displays.

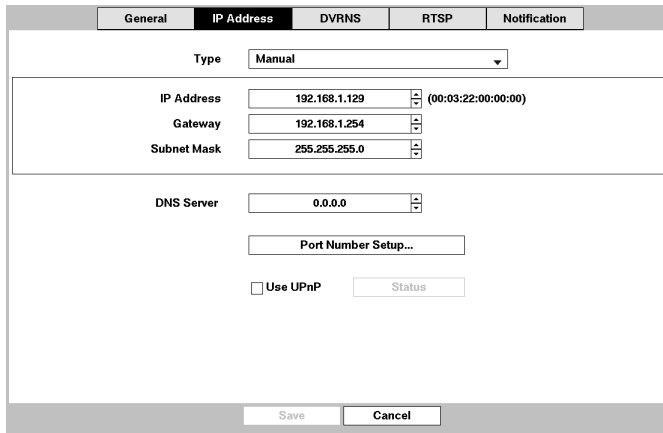



Figure 27 : Network – IP Address (Manual) setup screen.

Highlight the box beside Type and press the  button. You can select the type of network configuration from: Manual, DHCP and ADSL (with PPPoE). Select the desired type and press the  button.

Selecting Manual from the Type allows you to set up LAN parameters manually.

Change the numbers by highlighting them and using the Up and Down arrow buttons to increase or decrease the number. The factory default LAN settings are:

IP Address: 192.168.1.129
 Gateway: 192.168.1.254
 Subnet Mask: 255.255.255.0

NOTE: You will need to get the appropriate IP Address, Gateway and Subnet Mask from your network administrator.

Highlight the box beside DNS Server. Press the Up and Down arrow buttons to set the IP address of the DNS server.

Highlight the Port Number Setup... box and press the  button. The Port Number Setup screen appears.

NOTE: You will need to get the appropriate Port Numbers for each Speco Central and Speco Remote related program (Admin, Callback, Watch and Search) from your network administrator.

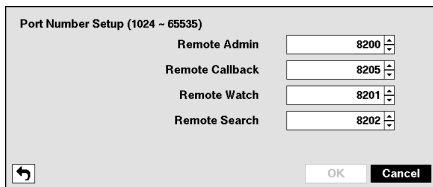

Change the numbers by highlighting them and using the Up and Down arrow buttons to increase or decrease the number. The factory default Port settings are:

Remote Admin: 8200
 Remote Callback: 8205
 Remote Watch: 8201
 Remote Search: 8202

NOTE: The system restarts automatically after changing the port settings.

Do NOT use the same port number for two different programs, otherwise, the DVR cannot be connected with the PC running Speco Central or Speco Remote.

CAUTION: When changing the port settings, you must change the port settings on the PC running Speco Central as well. Refer to the Speco Central Operation Instruction for details.

Highlight Use UPnP and press the  button to toggle between On and Off. When it is On, port forwarding from the NAT (Network Address Translation) device to the DVR will be enabled automatically via UPnP (Universal Plug and Play) service. This function will be especially useful when accessing a port on a private IP address.

NOTE: For the UPnP service to work, the NAT device should support the UPnP Port Forwarding function and the function should be set to enabled.

You cannot change the port settings when Use UPnP is On.

Highlight the Status box and press the  button to display the port numbers forwarded from the NAT device via UPnP service.

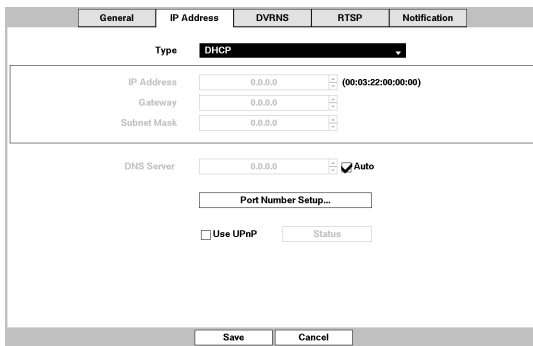

The screenshot shows the 'IP Address' configuration page with the 'Type' dropdown set to 'DHCP'. The 'IP Address' field is highlighted. Below it are fields for 'Gateway' and 'Subnet Mask', both set to '0.0.0.0'. A 'DNS Server' field is set to '0.0.0.0' with an 'Auto' checkbox checked. A 'Port Number Setup...' button is visible, along with a 'Use UPnP' checkbox and a 'Status' button. 'Save' and 'Cancel' buttons are at the bottom.

Selecting DHCP from the Type and highlighting Save button reads the current IP address of the DVR configured by DHCP (Dynamic Host Configuration Protocol) network.

Highlight Auto (Default) and press the  button to toggle between On and Off. When it is On, the DVR will obtain the IP address of the DNS server automatically.

NOTE: Selecting Auto will only be enabled when the DVR is configured for DHCP or an ADSL network.

Selecting ADSL (with PPPoE) allows you to set up the ADSL network.

Highlight the box beside ID and press the  button. A virtual keyboard appears allowing you to enter the ID for ADSL connection.

Highlight the box beside Password and press the  button. A virtual keyboard appears allowing you to enter the password for ADSL connection.

NOTE: Entering the ID and Password and highlighting OK reads the current IP address of the DVR configured by the ADSL network.

If the DVR is configured for DHCP or an ADSL network, the IP address of the DVR might change whenever the unit is turned on.

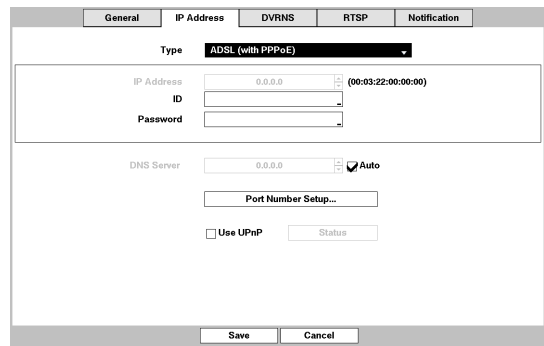

The screenshot shows the 'IP Address' configuration page with the 'Type' dropdown set to 'ADSL (with PPPoE)'. The 'IP Address' field is highlighted. Below it are fields for 'ID' and 'Password', both with dropdown menus. A 'DNS Server' field is set to '0.0.0.0' with an 'Auto' checkbox checked. A 'Port Number Setup...' button is visible, along with a 'Use UPnP' checkbox and a 'Status' button. 'Save' and 'Cancel' buttons are at the bottom.

DVRNS

Highlight DVRNS and press the  button, and the DVRNS setup screen displays.

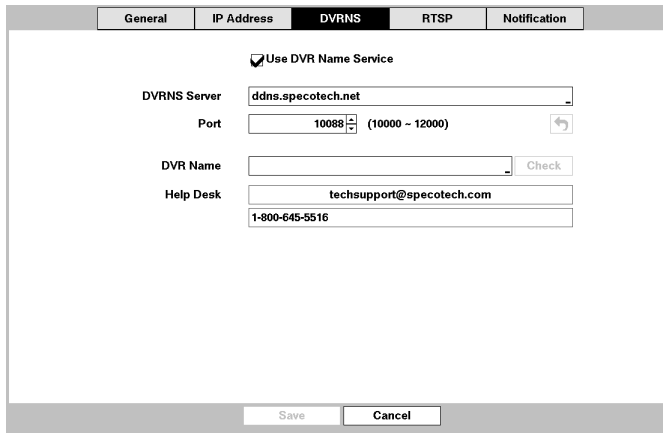



Figure 28 : Network – DVRNS setup screen.

Highlight Use DVRNS and press the  button to toggle between On and Off.

NOTE: DVRNS is the technology that automatically sets up your DVR to work seamlessly for remote viewing via your network internet connection. For DVRNS to work, naming your DVR will be required.

Highlight the box beside DVRNS Server and press the  button. A virtual keyboard appears allowing you to enter the IP address or domain name of the DVRNS server.

NOTE: You will need to get the IP Address or domain name of the DVRNS Server from your network administrator. You can use the domain name instead of IP address if you already set up the DNS Server when setting up the LAN.

Highlight the box beside Port and press the  button. Set the port number of the DVRNS server using the Up and Down arrow buttons to increase or decrease the numbers.

Highlight the box beside DVRNS Name and press the  button. A virtual keyboard appears allowing you to enter the DVR name to be registered on the DVRNS server.

Highlight the Check box and press the  button to check whether or not the name you entered can be used.

NOTE: The DVRNS Name you entered should be checked by selecting Check, otherwise the DVRNS changes will not be saved.

When entering no name or a name already registered on the DVRNS server, an error message displays.

Highlighting Save and pressing the  button registers the DVR on the DVRNS server. Proper DVRNS settings will display the help desk information of the DVRNS server in the box beside Help Desk.

RTSP

Highlight RTSP and press the  button. The RTSP setup screen displays.









Figure 29 : Network – RTSP setup screen.

Highlight Enable RTSP (Real-Time Streaming Protocol) and press the  button to toggle between On and Off. You will be able to change the settings if Enable RTSP is enabled.

Highlight the box beside RTSP Port and press the  button. Set the port number of the RTSP server obtained from your system administrator.

Highlight the box beside RTP Start Port and press the  button. Set the start port number of the RTP server obtained from your system administrator.

Highlight the box beside RTP End Port and press the  button. Set the end port number of the RTP server obtained from your system administrator.

Highlight Use Mobile and press the  button to toggle between On and Off. When set to on, you can access a remote DVR using a Blackberry or other mobile devices.

NOTE: Selecting *Use Mobile* sets the Speco Remote service to be enabled automatically regardless of Speco Remote settings.

When using NAT (Network Address Translation) or firewall services, opening all UDP ports allows you to access a DVR using Blackberry and Android devices.

You can access a remote DVR and monitor live video images using media players, such as VLC Player, supporting RTSP service. Start the media player on your local PC and enter “rtsp://ID:Password@IP address:RTSP port number/track ID=‘channel number’”, or start Internet Explorer on your Blackberry or other mobile devices and enter “http://IP address:Speco Remote port number?”.

Some media players might play video properly depending on network conditions.

RTSP service might not be supported, depending on the type of media player.

Notification

Highlight Notification and press the button. The Notification setup screen displays.

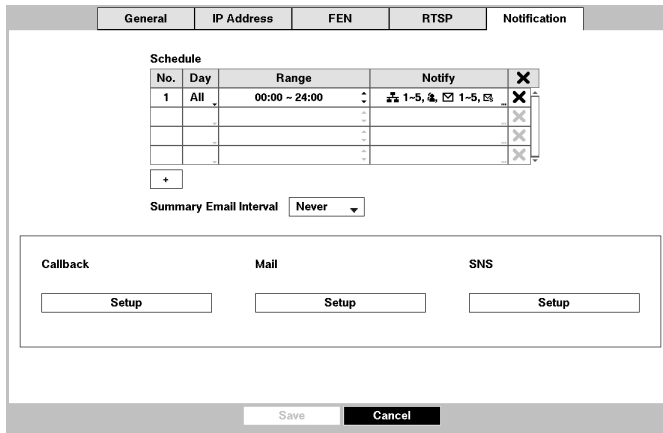

Figure 30 : Network – Notification setup screen.

You can add and edit notification schedules. Highlight the + and press the button to add a schedule. Highlighting the boxes under the Column heading and pressing the button allows you to edit the information in those boxes.

The Day box allows you to select the days that the notification schedule will be active. The choices are: Sun, Mon, Tue, Wed, Thu, Fri, Sat, M-F, Hol and All.

The Range box allows you to set the time that the notification schedule will be active in 15-minute increments from 00:00 to 24:00.

Highlight the desired box under the Notify heading, and press the button. The Schedule Notify menu appears.

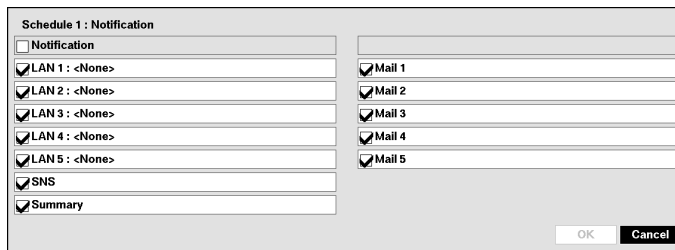

You can toggle the entire list On and Off by highlighting Notification and pressing the button. You can toggle the individual items On and Off by highlighting that item and pressing the button. Highlight OK and press the button to accept your changes.

NOTE: For the Notify action, the notify item you select should be enabled in the Notification setup screen and the DVR should be registered in the Speco Central (Remote Administration System).

Highlight the box beside Summary Email Interval and select the interval that you want the DVR to send a summary email. The DVR will send an email containing a summary of events detected during the preset interval.

Highlight Callback – Setup and press the button, and the Callback screen appears. The DVR can be set up to contact a computer running Speco Central (Remote Administration System) when an event occurs.

Highlight the box under the No. heading and press the button to toggle between On and Off. You will only be able to change the IP addresses if No. is enabled.

Highlight the IP Address box that you want to change and press the button. Use the arrow buttons to enter the IP address of the computer you want contacted during an event. You can enter up to five IP addresses.

Highlight the box beside Retry and enter the number of times you would like the DVR to try contacting the computer. You can select from 1 to 10 retries.

Highlight Mail – Setup and press the button, and the Mail screen appears. The DVR can be set up to send an email when an event occurs.

The Mail account can be turned On or Off by highlighting the boxes under the No. heading and pressing the button.

Highlight the + and press the button to add a mail recipient.

Highlight the first box under Recipient and press the button. A virtual keyboard appears that you can use to enter the recipient's e-mail address.

Highlight the second box under Recipient and press the button. You can select between Manual and listed SMTP mail server providers.

NOTE: The e-mail address must include the “@” character to be a valid address.

Highlight the box under the heading and press the button to toggle between On and Off. The DVR will clip an event detected video segment and attach it to an email when the box is turned On.

NOTE: Attaching a video clip to an email will not be available for the Text-In event.

Highlight MP4 Clip and press the button to toggle between On and Off. When it is On, the DVR will attach the event detected image file with MP4 format to an email.

The Mail accounts can be deleted by highlighting the beside the account and pressing the button.

Highlight SMTP Setup and press the button. The SMTP Setup screen appears.

Highlight the box beside Type and press the button. You can select between Manual and listed SMTP mail server providers.

Highlight the box beside SMTP Server and press the button. A virtual keyboard appears that you can use to enter the IP address or domain name of the SMTP server.

NOTE: You will need to get the IP Address or domain name of the SMTP Server from your network administrator.

You can use the domain name instead of IP address if you already set up the DNS Server when setting up the Network – IP Address.

Highlight the box beside Port and press the button. Use the arrow buttons to enter the SMTP Server port number obtained from your system administrator. The default port number is 25.

Highlight Use SSL/TLS and press the button to toggle between On and Off. When it is On, the DVR can send an email via an SMTP server requiring SSL (Secure Sockets Layer) authentication.

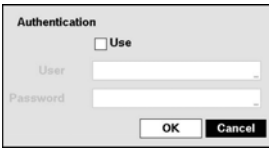

Highlight the box beside Authentication and press the button. An Authentication screen appears. Highlight Use and press the button to toggle between On and Off. Highlight the box beside User/Password and press the button. A virtual keyboard appears allowing you to enter the user ID and password.

NOTE: This product includes software developed by the OpenSSL Project for use in the OpenSSL Toolkit (<http://www.openssl.org/>).

Highlight the box beside Sender and enter the sender’s e-mail address. Use the virtual keyboard to enter the e-mail address.

NOTE: The e-mail address must include the “@” character to be a valid address.

Highlight the Test box and press the button to test emailing with the current settings you made.

Highlight SNS – Setup and press the button, and the SNS screen appears. The DVR can be set up to post a message via SNS (Social Network Service) when an event occurs.

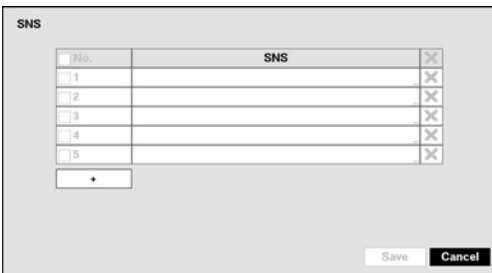

You can add and edit the SNS account on this screen. The SNS account can be turned On or Off by highlighting the boxes under the NO. heading and pressing the button.

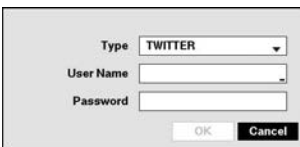

To add an SNS account, highlight the + and press the button. Highlight the box beside Type and press the button. Selecting TWITTER from the Type allows you to post a tweet on Twitter when an event occurs.

Highlight the box beside User Name/Password and press the button. A virtual keyboard appears allowing you to enter the user name and password.

The SNS accounts can be deleted by highlighting the beside the account and pressing the button.

NOTE: Posting a tweet might fail because of Twitter limitations.

Device Setup

Local Audio

Highlight Local Audio and press the button, and the Local Audio setup screen appears.

Local Audio	Network Audio	Digital Deterrent	Alarm-Out	Remote Control										
<table border="1"> <thead> <tr> <th>No.</th> <th>Associated Camera</th> </tr> </thead> <tbody> <tr> <td>1</td> <td>None</td> </tr> <tr> <td>2</td> <td>None</td> </tr> <tr> <td>3</td> <td>None</td> </tr> <tr> <td>4</td> <td>None</td> </tr> </tbody> </table>					No.	Associated Camera	1	None	2	None	3	None	4	None
No.	Associated Camera													
1	None													
2	None													
3	None													
4	None													
<input type="button" value="Save"/> <input type="button" value="Cancel"/>														

Figure 31 : Device – Local Audio setup screen.

The DVR can record up to four audio inputs. Highlight the box beside the input and press the  button. A list of local cameras appears, and you can select which camera you want associated with that audio input.

Network Audio

Highlight Network Audio and press the  button, and the Network Audio setup screen appears.

Local Audio	Network Audio	Digital Deterrent	Alarm-Out	Remote Control										
<table border="1"> <thead> <tr> <th>Network Camera</th> <th>Associated Audio</th> </tr> </thead> <tbody> <tr> <td>NETCAM17</td> <td>None</td> </tr> <tr> <td>NETCAM18</td> <td>None</td> </tr> <tr> <td>NETCAM19</td> <td>None</td> </tr> <tr> <td>NETCAM20</td> <td>None</td> </tr> </tbody> </table>					Network Camera	Associated Audio	NETCAM17	None	NETCAM18	None	NETCAM19	None	NETCAM20	None
Network Camera	Associated Audio													
NETCAM17	None													
NETCAM18	None													
NETCAM19	None													
NETCAM20	None													
<input type="button" value="Save"/> <input type="button" value="Cancel"/>														

Figure 32 : Device – Network Audio setup screen.

Highlight the box beside the network device input and press the  button. A list of local audio channels appears, and you can select which audio channel you want associated with that network device input. Audio from the selected channel will be sent to the network device that is associated with.

Digital Deterrent

Highlight Digital Deterrent and press the  button. The Digital Deterrent setup screen allows you to set up the DVR to sound when events are detected.

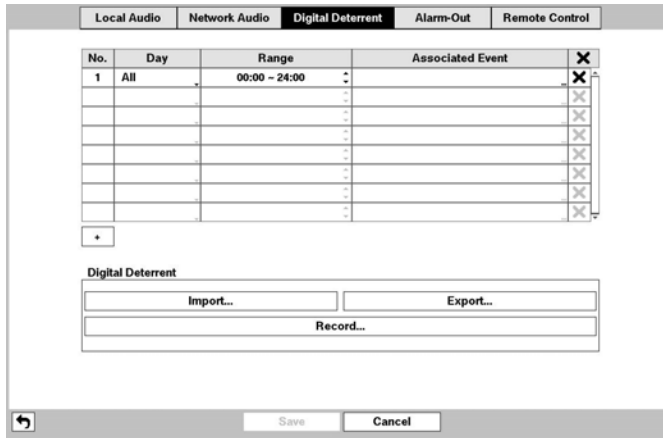





Figure 33 : Device – Digital Deterrent setup screen.

Highlight the + and press the  button to add a digital deterrent schedule item.

Highlight the box under the Day heading and press the  button to change the days that the scheduled digital deterrent will take place. Choose from: Sun, Mon, Tue, Wed, Thu, Fri, Sat, M-F, Hol and All.

Highlight the box under the Range heading and press the  button to change the time range that the scheduled digital deterrent will take place. The smallest time segment you can use is 15 minutes.

Highlight the box under the Associated Event heading and press the  button to select which events you want associated with each digital deterrent.

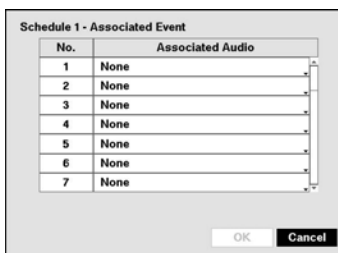

You can select the audio files associate with each event. Highlight the box under the Associated Audio and press the  button. A list of audio file name appears, and you can select which audio file you want to associated with that event.



You can import saved audio files or export the current audio files. To import saved audio files, connect the USB device containing the audio file (.aaf or .wav) to the DVR. Highlight Digital Deterrent – Import... and press the  button. Select the desired audio file and press the Import button to import the selected audio file and change the audio file accordingly.

NOTE: File format has to be mono G.711 ulaw 16KHz/16bit sampling.



The file names have to be "Sound_1.wav" ~ "Sound_16.wav" or "Sound_1.aaf" ~ "Sound_16.aaf" for USB import. (USB has to be in FAT32)

The files have to be in the top folder of the USB flash drive.

The file name format is case insensitive.

If the audio file in .wave format, it will be converted to .aaf file in 10 seconds when imported.









To export the current audio files, connect the USB device to the DVR. Highlight Digital Deterrent – Export... and press the  button. Highlight the box beside File name and press the  button. A virtual keyboard allows you to enter the file name. Selecting Export will save the current audio file in .aaf file format on the USB device.



Highlight Digital Deterrent – Record... and press the  button. You can extract audio files from recorded audio on the DVR.



Highlight the box beside Channels and press the  button. You can select the cameras with recorded audio you want to extract audio files from.

Highlight the box beside From and press the  button to toggle between On and Off. When set to Off, you can enter a specific Date and Time. When set to On, the search will be from the first recorded audio. When highlighting  and pressing the  button the bookmark list displays and the bookmark point you selected will be the starting date and time.

Highlight the box beside To and press the  button to toggle between On and Off. When set to Off, you can enter a specific Date and Time. When set to On, the search will be to the last recorded audio. When highlighting  and pressing the  button the bookmark list displays and the bookmark point you selected will be the ending date and time.

Highlight the box beside File name and press the  button to select the file name. The selected audio file can be listened by highlighting  and pressing the  button.

Once you have selected the file name, highlight the Start button and press the  button to record the extracted audio file (up to 10 seconds).

Alarm-Out

Highlight Alarm-Out and press the  button. The Alarm-Out screen allows you to change the settings and establish a schedule for each alarm output from the DVR.

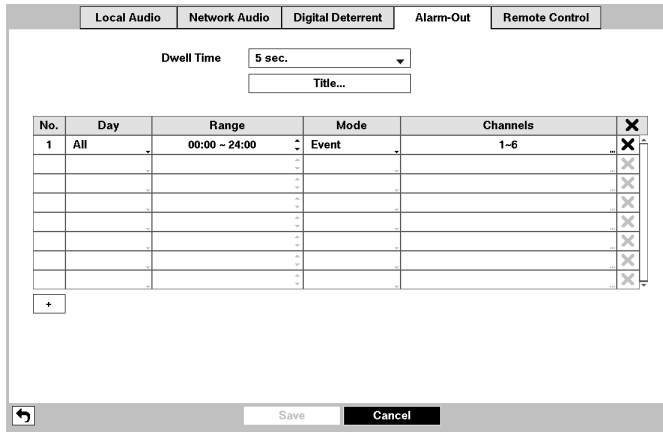







Figure 34 : Device – Alarm-Out setup screen.

Highlighting the box beside Dwell Time and pressing the  button allows you to set the dwell time of the alarm output. Dwell times range from 5 seconds to 15 minutes.

Each alarm output can be given its own title by highlighting Title... and pressing the  button. A virtual keyboard appears allowing you to enter the title.

You can add and edit alarm output schedules. Highlight the + and press the  button to add a schedule. Highlighting the boxes under the Column heading and pressing the  button allows you to edit the information in those boxes.

Highlighting the boxes under the Day box and pressing the  button allows you to select the days that the alarm schedule will be active. The choices are: Sun, Mon, Tue, Wed, Thu, Fri, Sat, M~F, Hol and All.

Highlighting the boxes under the Range box and pressing the  button allows you to set the time that the alarm schedule will be active in 15-minute increments from 00:00 to 24:00.

Highlighting the boxes under the Mode box and pressing the  button allows you to set how the alarm reacts during the scheduled time. When set to On, the Alarm-Out is active during the scheduled time. When set to Event, the Alarm-Out is only active when there is an Event during the scheduled time.

Highlighting the boxes under the Channels box and pressing the  button allows you to set which alarm outputs will be active. You can also select the DVR's internal buzzer.

The X box allows you to delete an alarm output schedule. You will be asked to confirm whether or not you really wish to delete the schedule.

Remote Control

Highlight Remote Control and press the  button. The Remote Control setup screen allows you to select a port and make correct settings for a remote keyboard.

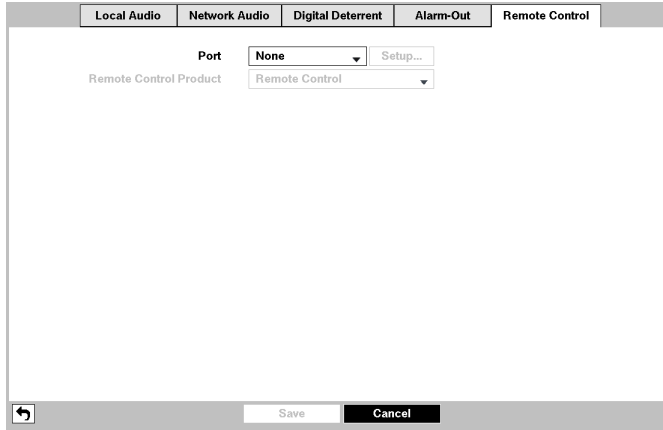

Figure 35 : Device – Remote Control setup screen.

Highlight the box beside PORT and select from None, RS232 and RS485. If the RS232 port and RS485 port are in use for PTZ control, networking or text input, the remote keyboard cannot be configured.

Highlight Setup... and select the correct Baud Rate, Parity, Data Bits and Stop Bits for the device you are connecting to the DVR.

Highlight the box beside Remote Control Product and select the device from the list.

Display Setup

OSD

Highlight OSD and press the  button. The OSD screen allows you to select what information will be displayed on the monitor.

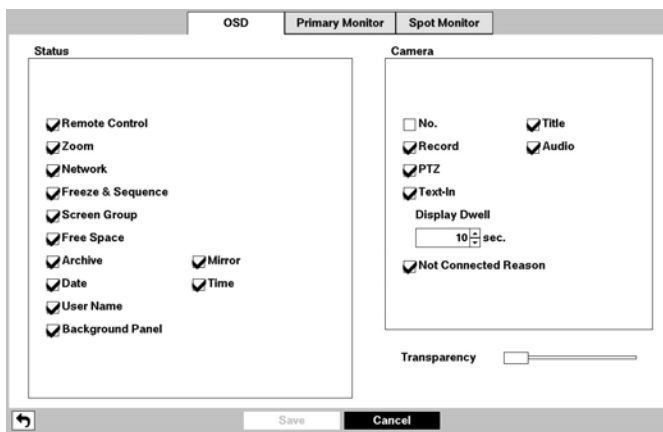















Figure 36 : Display – OSD setup screen.

Highlighting an item and pressing the  button toggles that item On and Off. When an item is On, there is a checkmark in the box beside it. The following items can be turned On or Off:

- Remote Control – The icon  displays when the DVR can be controlled by the infrared remote control.
- Zoom – The icon  displays on the enlarged video.
- Network – The icon  displays when the unit is connected to a network via Ethernet. The icon  displays on each camera when audio communication is available between the DVR and a PC running Speco Central via Ethernet. The icon  displays when VNC service is running.
- Freeze & Sequence – The icon  displays while in the Freeze mode, and the icon  displays while in the Sequence mode.
- Screen Group – The number of screen group displays when the DVR is not in the 5x4 display mode of the 16-channel DVR, and 4x3 mode of the 8-channel DVR.
- Free Space – The icon  displays when the DVR is in the Recycle mode, and the percentage of available storage space displays when the DVR is not in the Recycle mode.
- Archive – The icon  displays when the DVR is archiving recorded data.
- Mirror – The icon  displays when the DVR is disk mirroring.
- Date/Time – The current date and time information displays.
- User Name – The name of the current user logged in displays.
- Background Panel – The background panel at the bottom of the screen displays in black.
- Camera No. – The camera number displays at the top-left corner of each camera screen.
- Camera Title – The camera title displays at the top-left corner of each camera screen.
- Record – The record related icons display on each camera screen.
- Audio – The icon  displays on each camera screen for which the DVR can play live audio.
- PTZ – The icon  displays on each PTZ camera screen.
- Text-In – The text input strings display on the screen. You can adjust the Display Dwell time (sec.) for the text input strings displayed on the screen.
- Not Connected Reason – The error code displays on the associated camera screen when the network device is not connected properly. Refer to *Appendix – Error Code Notices* for error code information.

You can adjust the transparency of the setup screens by highlighting Transparency and using the Left and Right arrow buttons.

Primary Monitor

Highlight Primary Monitor and press the  button, and the Primary Monitor setup screen appears.

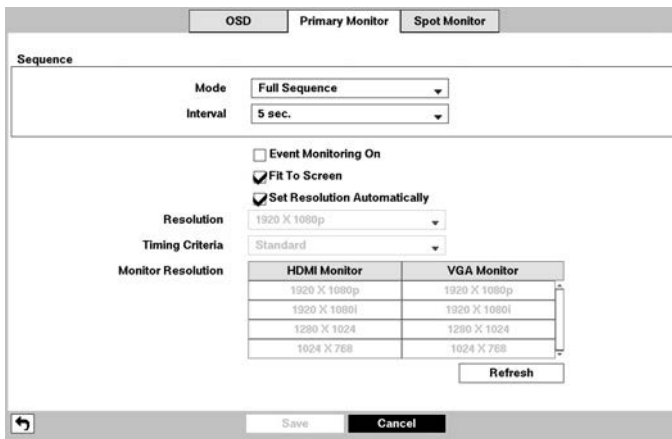





Figure 37 : Display – Primary Monitor setup screen.

Highlight the box beside Mode and press the  button. You can select between Full Sequence and Cameo Sequence.

Pressing the  button or selecting  (Sequence) in the Live Monitoring menu causes the DVR to sequence cameras, and the DVR can sequence cameras in two modes: “Full” and “Cameo”. In the Full mode, the DVR sequences through the cameras and displays them full screen. In the Cameo mode, the bottom right window in a multi-screen format sequences through the cameras.

NOTE: Any cameras that are Off, have lost video or are set to Covert (unless the user has authority to view covert cameras) will be excluded from the Cameo sequence.

You can define the screen layout in a variety of formats and set the DVR to sequence through the different screen layouts (pages) so that all the cameras will be displayed. You can also set up the DVR to display one camera or a group of cameras all the time while cycling through the remaining cameras in a “cameo” window. This can be done with one camera displayed full screen while displaying the cameo window as a PIP (picture in picture), or displaying the cameras in a grid pattern with the bottom right window as the cameo.

NOTE: Sequence cannot be used in the 5x4 display mode of the 16-channel and 4x3 mode of the 8-channel DVR.

You can adjust the display dwell time by highlighting the box beside Interval and pressing the button. You can select dwell intervals ranging from 3 seconds to 2 minutes.

Highlight Event Monitoring On and press the button. Pressing the button toggles between On and Off. When it is On, the DVR will display the camera associated with the event when an event occurs.

Highlight Fit To Screen and press the button. Pressing the button toggles between On and Off. When it is On, the DVR will resize video to fit the primary monitor screen.

Highlight the box beside Set Resolution Automatically and press the button. Pressing the button toggles between On and Off. When it is On, the resolution will automatically be set to the maximum resolution supported on the monitor when the DVR reboots.

Highlight the box beside Resolution and press the button. You can select from 1920x1080p, 1920x1080i, 1280x1024 and 1024x768.

NOTE: Changing the resolution-related settings will NOT be applied until you have highlighted Save and pressed the button. A screen will appear confirming that you will need to restart the system to applying the resolution you set.

Highlight the box beside Timing Criteria and press the button. You can select from “Standard”, “HDMI Monitor Optimized” and “VGA Monitor Optimized.”

Monitor Resolution displays the resolution information of monitors current connected to the DVR. Highlighting Refresh pressing the button refreshes the resolution information.

Spot Monitor

Highlight Spot Monitor and press the button, and the Spot Monitor setup screen appears.

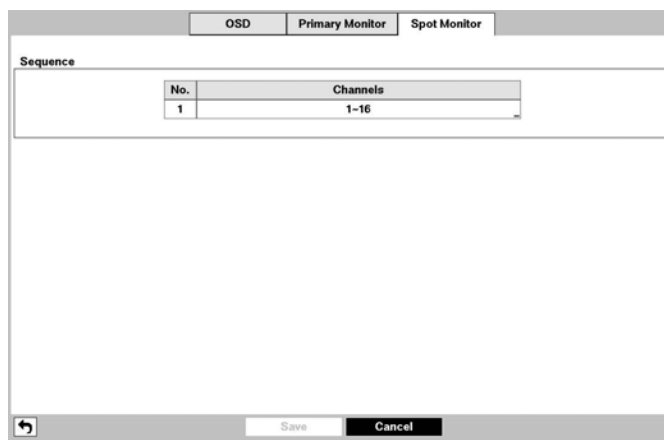
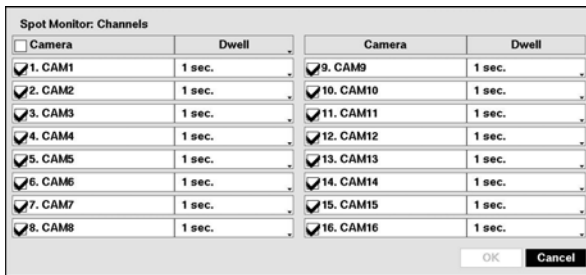



Figure 38 : Display – Spot Monitor setup screen.

Highlight the box in the Channels column and press the button.



You can define which cameras display sequentially on the Spot Monitor when in the single-screen display format. Highlighting the box under the Camera and pressing the  button toggles between On and Off.

You can adjust the display dwell time by highlighting the box under the Dwell and pressing the  button. You can select dwell intervals ranging from 1 to 20 seconds.

Pressing the  button or selecting  (Sequence) in the Live Monitoring menu causes the DVR to sequence cameras.

NOTE: Sequence cannot be used in the 4x4 display mode of the 16-channel.

Monitoring and playing back video from network devices is not supported on the SPOT monitor.

Status Setup

Event

Highlight Event and press the  button, and the Event setup screen appears.

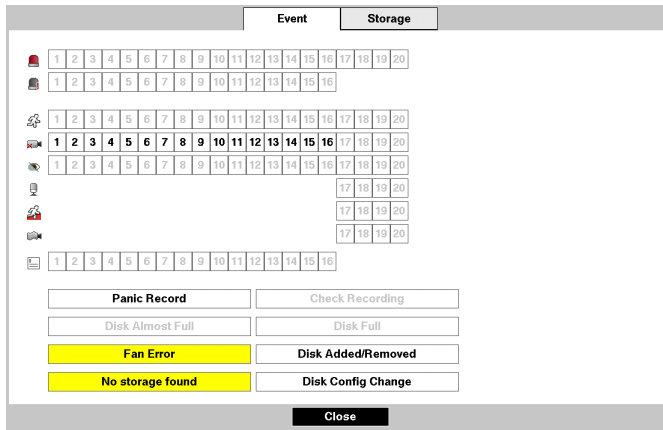





Figure 39 : Status – Event setup screen.

The Event Status screen displays the status of the DVR's systems and inputs. Events will be highlighted, and related channels or events will flicker for five seconds when detected.

 (Alarm-In),  (Motion),  (Video Loss),  (Video Blind) and  (Text-In) will be highlighted when each event is detected based on the settings you made in the Alarm-In, Motion, Video Loss, Video Blind and Text-In setup screen on the Event menu.

 (Check Alarm-In) and Check Recording will be highlighted when each event is detected based on the settings you made in the Monitoring setup screen on the System menu.

Panic Record will be highlighted while the DVR is in the panic recording mode.

Disk Almost Full will be highlighted when the DVR is not in the Recycle mode and the level of disk usage reaches the Disk Almost Full percentage you made in the System Event setup screen on the Event menu. Disk Full will be highlighted when the DVR is not in the Recycle mode and all available storage space has been used.

Fan Error will be highlighted when the cooling fan to the left of the power cord on the rear panel is not working for more than four seconds.

Disk Added/Removed will be highlighted when the hard disk drive is connected or disconnected while the DVR is operating.

No storage found will be highlighted when there is no storage device for recording is installed in the DVR when the DVR boots for the first time.

Disk Config Change will be highlighted when the DVR reboots after the hard disk drive has been replaced.

Storage

Highlight Storage and press the  button, and the Storage setup screen appears.

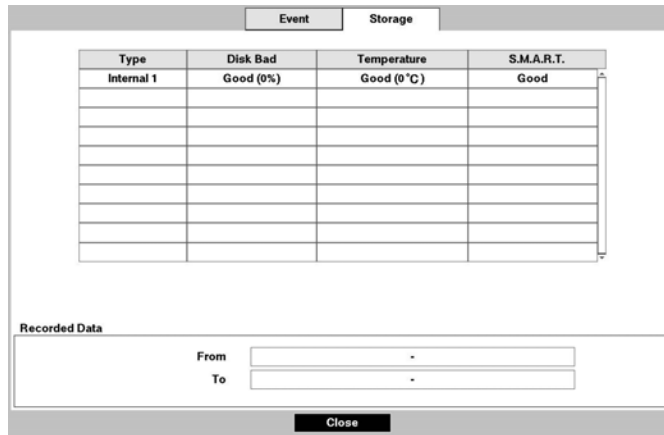

Type	Disk Bad	Temperature	S.M.A.R.T.
Internal 1	Good (0%)	Good (0°C)	Good

Recorded Data

From

To

Close

Figure 40 : Status – Storage setup screen.

The Type column displays the type of storage device.

The Disk Bad column displays the percentage of bad sectors. **Not formatted** indicates the device is not formatted.

The Temperature column displays the temperature of the storage device.

The S.M.A.R.T. column displays “Good”, “Bad” or “N/A”, depending on storage conditions.

- Good – The storage condition is normal.
- Bad – Data cannot be written on or read from the storage device.
- N/A – Storage conditions are normal, however, the S.M.A.R.T. monitoring is not working or supported.

NOTE: When the storage condition is “Bad”, the Event Status – Storage screen displays and you can check the storage condition for details. Once the “Bad” message displays, replacing the hard disk drive is recommended, usually within 24 hours.

Temperature and *S.M.A.R.T.* information will be available only for internal hard disk drives supporting the SMART (Self-Monitoring Analysis and Reporting Technology) monitoring program.

The box beside Recorded Data – From / To displays the time information of recorded data.

Camera Setup

General

Highlight General and press the  button, and the General setup screen appears. (Local Cameras Only)

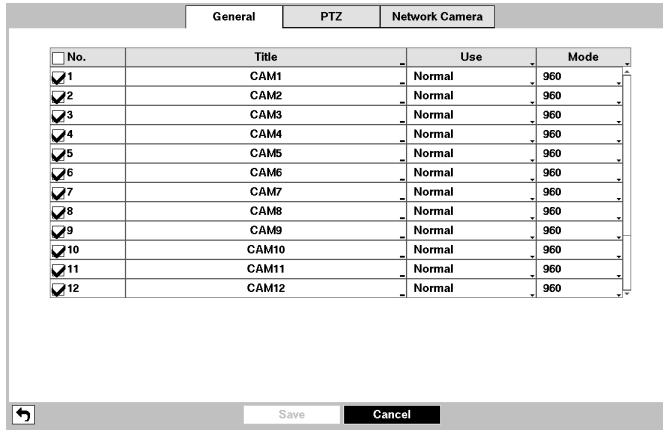

Figure 41 : Camera – General setup screen.

You can turn the camera number On or Off, and you can change the Title of each camera using the virtual keyboard. You can also determine which cameras will display on the monitors by selecting Normal, Covert 1 or Covert 2 from a drop-down list in the Use column.

NOTE: When selecting the *Covert 1*, the DVR displays the camera title and status icons on the covert video. When selecting the *Covert 2*, the DVR displays only camera title on the covert video.

A user who does not have *Covert Camera View* authority cannot view video from cameras set to *Covert 1* or *Covert 2* in both the live monitoring and playback modes.

You can select the width resolution supported by the camera between 720 and 960 by highlighting the box under the Mode heading and pressing the button.

NOTE: The system restarts automatically after changing the resolution settings.

When selecting the *960 Mode*, the total recording speed and playback speed will decrease.

PTZ

Highlight PTZ and press the button, and the PTZ setup screen appears. (Local Cameras Only)

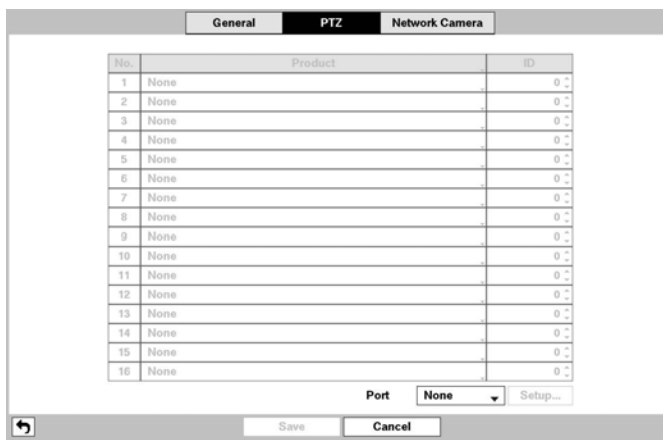
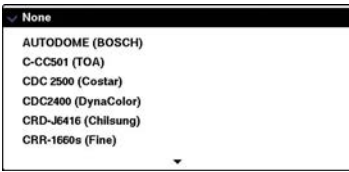

Figure 42 : Camera – PTZ setup screen.

NOTE: You will only be able to set up PTZ devices if the PTZ port is set to RS232 or RS485.



Highlight the box in the Product column for the PTZ camera you wish to configure and press the **←** button. A list of PTZ devices appears. Select your camera from the list and press the **←** button. You will need to connect the camera to the RS232 or RS485 connector on the back of the DVR following the camera manufacturer’s instructions.

You can assign IDs to each camera by highlighting the box under the ID heading and pressing the **←** button. Change the number by highlighting it and using the Up and Down arrow buttons to increase and decrease the number. The PTZ ID number can be set from 0 to 256.

Highlight the Setup... box and press the **←** button. The Port Setup window appears.

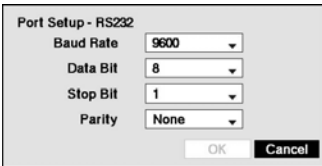

Configure the port’s setting based on the PTZ camera manufacturer’s instructions.

Network Camera

Highlight Network Camera and press the **←** button, and the Network Camera setup screen appears. (Network Devices Only)

NOTE: “Network Camera” includes both network cameras and network video transmitters.

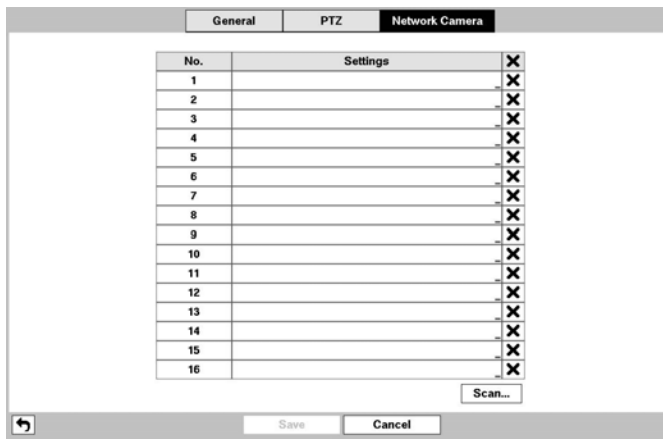
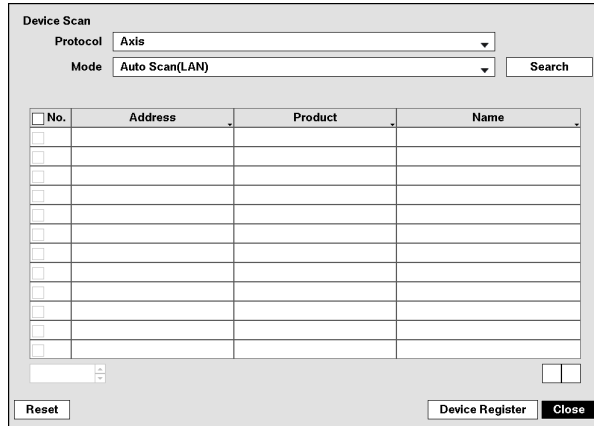

Figure 43 : Camera – Network Camera setup screen.

Highlight the Scan... box and press the **←** button, and the Device Scan setup screen appears.



Highlighting the box beside Protocol and pressing the button allows you to select the protocol for the network device you want to search.

NOTE: Refer to the network device manufacturer’s instructions about enabling the ONVIF™ Conformance protocol in the device, as procedures may differ for each model.

Highlight the box beside Mode, and press the button. You can select the scan mode between Auto Scan (LAN), IP Address Scan and Domain Name Scan. Select the desired mode and press the button.

NOTE: The supported scan modes differ depending on the protocol you selected.

If the IP address range of the device is different from that of the DVR, the DVR considers the IP address invalid. In this case, you must change the device’s IP address to register the device.

Selecting Auto Scan (LAN) from Mode scans network devices automatically.

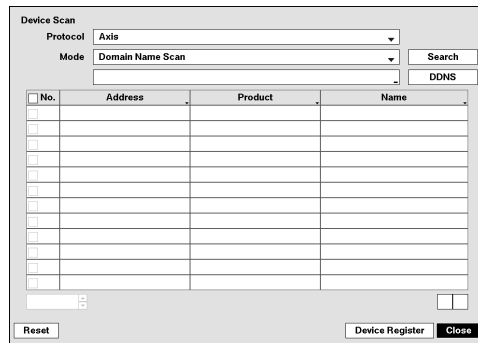
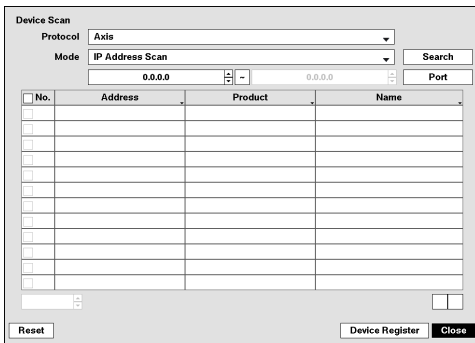

Selecting IP Address Scan from Mode scans network devices by entering a specific IP address or adjusting the IP address range. Highlighting Port and pressing the button allows you to set the port number used for remote monitoring.

NOTE: Using the IP Address Scan, you can search for a network device that cannot be searched for using the Auto Scan (LAN) mode.

Selecting Domain Name Scan from Mode scans network devices by entering the domain name of the network device. Highlighting Port and pressing the button allows you to set the port number used for remote monitoring.



NOTE: For the Domain Name Scan feature to work, the DNS sever should be configured during Network – IP Address setup.

After selecting the desired scan mode, highlighting Search and pressing the button, the system searches for network devices and displays them in the list. Selecting Reset allows you to delete the search results list.

NOTE: Depending on the model of network device, the device may not be supported even though the DVR supports the device's protocol. Ask your dealer or distributor about supported device models.

Highlight **Device Register** and press the  button to register the selected network device(s) from the list. An Authentication screen appears. Setting up the Authentication is required to register the network device to the DVR.





Highlight the box beside **User/Password** and press the  button. A virtual keyboard appears allowing you to enter the user ID and password. Highlight **Apply to All Devices** and press the  button to apply the same authentication information to all the network devices in the list. When selecting multiple network devices in the list, selecting **Skip** skips the authentication settings for the current network device and displays the Authentication screen of the next network device.

Proper registration and authentication settings will display registered devices in the list of the Network Camera setup screen. Highlighting the box under the **Settings** heading and pressing the  button allows you to change the device settings.

NOTE: The Settings screen will differ depending on the type of protocol that you selected. The following description is for a network device using the ONVIF™ Conformance protocol.





Highlight **Enable** and press the  button to toggle between On and Off. When it is On, you will be able to change the device settings.

Highlight the box beside **Name** and press the  button. A virtual keyboard appears allowing you to edit the device name.

You can assign IDs to each camera by highlighting the box beside **Camera ID** and pressing the  button. Change the number by highlighting it and using the **Up** and **DOWN** arrow buttons to increase and decrease the number. (4-ch Network Video Transmitter Only)

Highlighting the box beside **Address** and pressing the  button allows you to change the IP address of the device.

Highlight the box beside **User/Password** and press the  button. A virtual keyboard appears allowing you to enter the user ID and password used when changing device settings.

Highlighting the box beside **Stream Protocol** and pressing the  button allows you to select the protocol for streaming.

Highlighting the box beside **Record Protocol** and pressing the  button allows you to select the protocol for recording.

Highlighting the box beside **ONVIF Profile** and pressing the  button allows you to select a preset ONVIF™ profile.

Highlighting the **Port Number Setup...** box and pressing the  button allows you to select the HTTP server's port number and the RTSP server's port number.

Highlight **Authentication** and press the  button. An Authentication screen appears, and entering Authentication information is required to change the device settings.

Highlight **Use Audio Recording** and press the  button to toggle between On and Off. When it is On, the DVR will record audio from the device when video from the network device is recording.

Highlight the **Device Remote Setup** box and press the  button. The **Device Remote Setup** screen appears. See *Appendix – Remote Setup of Network Devices* for details.

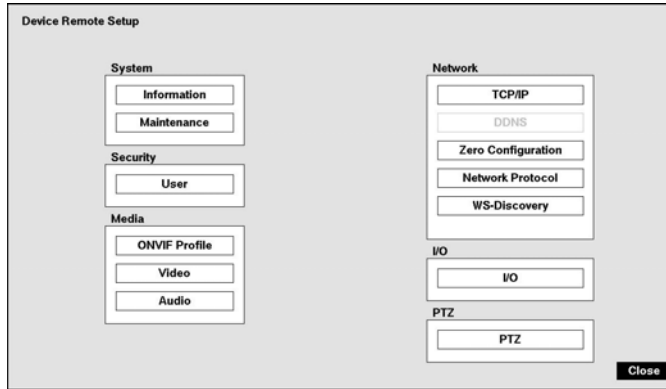

NOTE: When the device's settings have been changed using the tool provided by the device manufacturer, you might need to register the device to the DVR again for proper operation. Refer to the device manufacturer's instructions for proper settings.

Chapter 4 — Operation

NOTE: This chapter assumes your DVR has been installed and configured. If it has not, please refer to Chapters 2 and 3.

The DVR's controls are similar to a VCR. As with a VCR, the main functions are recording and playing back video. However, you have much greater control over recording and playing back video. You can establish recording schedules based on time of day and day of the week. The DVR allows you to search through the recorded video using much more sophisticated tools than those available with VCRs. Additional DVR features that are not available with VCRs are remote control and viewing, and recording video at the same time you are watching previously recorded video.

The front panel controls are described in *Chapter 3 — Configuration*.

Turning on the Power

Once you have installed the DVR following the instructions in *Chapter 2 — Installation*, it is ready to record.

Live Monitoring

As soon as the DVR completes its initialization process, it will begin showing live video on the attached monitor and playing live audio through the attached speaker. The default mode is to display all cameras at once. Pressing any camera button will cause that camera to display full screen. It displays live video and plays live audio until the user enters another mode.

While in the live monitoring mode, pressing the **MENU** button displays the following Live Monitoring menu on the right edge of the screen. Pressing the **ESC** button hides the menu. You can navigate through menus and items by pressing the arrow buttons.





Figure 44 : Live Monitoring menu.

- | | | | |
|----------------|---------------------|-----------|------------|
| ① Login/Logout | ② Monitor | ③ Display | ④ Freeze |
| ⑤ Alarm | ⑥ Digital Deterrent | ⑦ Panic | ⑧ Sequence |
| ⑨ Camera Menu | ⑩ Search | ⑪ Setup | |



NOTE: The Live Monitoring menu also can be displayed by moving the mouse pointer to the right edge of the screen.

Live Monitoring Menu

Login/Logout

Selecting  (Login) in the Live Monitoring menu accesses the Login screen, and you will be asked to select a User and enter the password to log into the system. Selecting  (Logout) in the Live Monitoring menu displays the Logout screen asking you to confirm whether or not you want to log out the current user.

Monitor





Selecting  (Monitor) in the Live Monitoring menu will allow you to select the monitor from Primary and Spot. Selecting Primary displays  and Spot displays . You can select the screen format and sequence monitoring of the selected monitor.

Display



- **Camera:** Selecting  (Display) → Camera and choosing the camera number displays the selected camera full screen. It is the same as pressing the individual camera buttons on the front panel or clicking the left mouse button on a camera image when in one of the multiview formats (i.e., PIP, 2x2, 3x2, 3x3, 4x3, 4x4 or 5x4). Clicking the left mouse button on the screen again returns to the previous display mode.

You can change the location of the PIP (Picture-in-Picture) counterclockwise or clockwise by pressing the Up and Down arrow buttons and change its size by pressing the Left and Right arrow buttons. To change its location and size by using the mouse, select the PIP and then click the right mouse button to display the following menu. Select the options you want. You can also change the location of the PIP by clicking the left mouse button on the PIP window and dragging it to where you want it located, and change the size of the PIP by clicking the left mouse button at the corner of the PIP window and dragging it until it is the desired size.



- **Screen Format:** Selecting  (Display) → Screen Format and choosing the screen mode displays the cameras in the selected multiview screen mode (PIP, 2x2, 3x2, 3x3, 4x3, 4x4 or 5x4). Selecting each display mode is the same as pressing the **MODE** button or scrolling the mouse wheel up and down when in one of the multiview formats.
- **Previous Group, Next Group:** Selecting  (Display) → Previous Group or Next Group moves to the previous or next page.
- **Edit Group:** Selecting  (Display) → Edit Group enters to the Active Cameo mode. Refer to the following *Active Cameo Mode* section for details.
- **Camera OSD, Status OSD:** Selecting  (Display) → Camera OSD or Status OSD toggles Camera OSD or Status OSD On and Off.

Freeze

Selecting  (Freeze) in the Live Monitoring menu will freeze the current image on the screen until you select  again. While in the Freeze mode, the icon  displays in bottom-left corner if Freeze is selected in the Display setup screen (OSD tab).

Alarm

Selecting  (Alarm) in the Live Monitoring menu resets the DVR's outputs including the internal buzzer during an alarm. It is the same as pressing the **ALARM** button.

Digital Deterrent

Selecting  (Digital Deterrent) in the Live Monitoring menu displays the following setup screen and allows the DVR to play manually.



Highlight the box beside **Source name** and press the button to select the source file to play. Highlighting **Trigger** plays the selected file as the digital deterrent.

Panic

Selecting (Panic) in the Live Monitoring menu starts panic recording of all cameras, and selecting again stops panic recording.

Sequence

Selecting (Sequence) in the Live Monitoring menu causes the cameras to display sequentially. It is the same as pressing the **SEQ** button. When in one of the multi-view formats, selecting will cause the DVR to go through predefined screen layouts (Full Sequence). Or, the bottom, right screen will display live cameras sequentially (Cameo Sequence). For example, if you select in the 2x2 format, the DVR changes pages as follows:

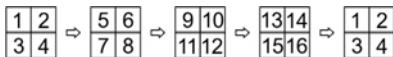

< Full Sequence >

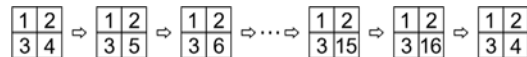

< Cameo Sequence >

Selecting again in the Live Monitoring menu exits the Sequence mode. While in the Sequence mode, the icon displays in bottom-left corner if Sequence is selected in the Display setup screen (OSD tab). If all the cameras in a page are Off, or have lost video or are set to Covert (unless the user has authority to view covert cameras), that page will be excluded from the sequence.

NOTE: The *Full Sequence* for the full sequence monitoring and the *Cameo Sequence* for the cameo sequence monitoring should be selected in the Display setup screen (Primary Monitor tab).

Camera Menu

- **PTZ:** Selecting (Camera Menu) → PTZ and choosing the camera number allows you to control the selected camera as long as it has Pan, Tilt and Zoom capabilities. It is the same as pressing the **PTZ** button. Refer to the following *PTZ Mode* section for details.
- **Zoom:** Selecting (Camera Menu) → Zoom and choosing the camera number zooms the current image of the selected camera on the screen. Refer to the following *Zoom Mode* section for details.
- **Audio:** Selecting (Camera Menu) → Audio toggles audio output On and Off.
- **Mic:** Selecting (Camera Menu) → Mic toggles the DVR's audio that is sent to the network device On and Off.
- **Color Control:** Selecting (Camera Menu) → Color Control and choosing the camera number allows you to control brightness, contrast, hue and saturation for each camera for the selected camera if a user who has Color Control authority logs into the system. It is the same as pressing and holding a camera button for a few seconds.
- **Information:** Selecting (Camera Menu) → Information and choosing the network camera number allows you to check the information of the selected network camera.

NOTE: It is important that cameras and monitors are correctly installed and adjusted prior to making any image adjustments using the DVR's controls.

Any image adjustments you make will be applied to both the live video on the monitors and the recorded video.

The *Camera Menu* also can be displayed by clicking the right mouse button on the screen while in the live monitoring mode.



Search

Selecting (Search) in the Live Monitoring menu exits the live monitoring mode and enters the search mode. It is the same as pressing the **PLAY/STOP** button.

Setup



Selecting  (Setup) in the Live Monitoring menu enters the Main Setup screen. Refer to *Chapter 3 – Configuration* for detailed descriptions of system setup.

Active Cameo Mode

You can enter the Active Cameo mode by selecting **Edit Group** from the Live Monitoring – Display menu or pressing the  button on the front panel in any multi-view format. The yellow outline surrounding the video indicates the active cameo, and pressing the arrow buttons moves the active cameo. Pressing the  button exits the Active Cameo mode. Selecting **Exit Group Edit** in the cameo menu displayed when pressing the **MENU** button also exits the Active Cameo mode. The active cameo mode will remain in effect for 15 seconds if there is no further operation.

In active cameo mode, press the button for the camera you want to display in the active cameo. After setting the camera number to active cameo, the DVR moves the active cameo to the next cameo. When the camera number exists on the current screen, the active cameo is changed with the existing camera number. When the camera number does not exist on the current screen, the active cameo is replaced by the camera number. You can change the screen layout in this way.

Zoom Mode

You can enlarge an area of the video by selecting **Zoom** from the Live Monitoring – Camera menu. For a few seconds after selecting **Zoom**, a rectangle displays on the screen. A rectangle shows the area that will be enlarged. You can move the rectangle around using the arrow buttons. Pressing the  button or turning the Jog Dial counterclockwise in the Zoom mode toggles the zoom size between 2x, 3x and 4x. Exit the Zoom mode by selecting  (Exit) in the Zoom menu displayed when pressing the **MENU** button. While in the Zoom mode, the icon  displays if **Zoom** is selected in the Display setup screen (OSD tab).

PTZ Mode

If a user who has PTZ Control authority logs into the system, the user can control PTZ cameras. The DVR will control cameras with Pan, Tilt and Zoom capabilities. Press the **PTZ** button to display the PTZ camera menu and enter the PTZ mode, and press the button again to exit the PTZ mode.

Select the PTZ camera you wish to control by selecting it from the menu. The icon  displays on the PTZ camera screen.

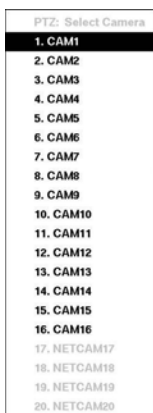

To use the front panel buttons, press the **Left** and **Right** arrow buttons to pan left and right. Press the **Up** and **Down** arrow buttons to tilt the camera up and down. Press the camera button 1 to zoom in, and press the button 4 to zoom out. You can use the button 2 and button 5 to focus the image.

You can establish preset positions for PTZ cameras. Press the button 6 to establish Presets.

You can quickly move PTZ cameras to Preset positions. Press the button 3 to view an established camera Preset position.

Figure 45 : PTZ Select Camera menu.

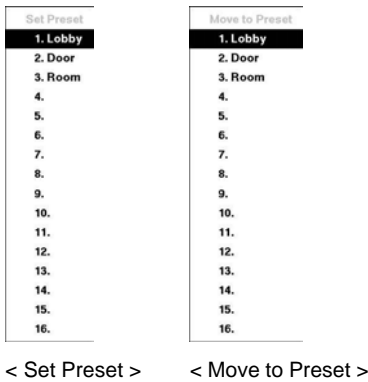

You can save camera position settings as “presets” so that you can go directly to desired views.

Once you have the camera at the desired settings, press the camera button 6, and the **Set Preset** dialog box will appear. Select the number you want to assign to the preset and press the button. Use the virtual keyboard to enter the preset name.

Press the camera button 3 to load the PTZ preset and the **Move to Preset** dialog box will appear. Select the desired preset and press the button to load the preset.

Figure 46 : PTZ Preset menu.



While in the PTZ mode, pressing the **MENU** button and selecting (Advanced PTZ) in the menu displaying at the top of the screen displays the Advanced PTZ menu.

Set the feature you wish to control by selecting it from the menu. Refer to the camera manufacturer’s instructions for the proper settings. Depending on the camera specifications, some features may not be supported.

You can use a mouse for convenient PTZ control. Click the left mouse button on the image and move that image in the direction you want to by dragging the mouse. Use the mouse wheel to zoom in and out. Position the mouse pointer at the bottom of the screen, and the following PTZ toolbar will display.

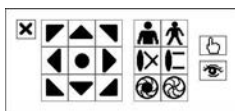

Clicking on the left side exits the toolbar. If you want to display the toolbar again, position the mouse pointer at the bottom of the screen. Change the toolbar location by clicking the empty space on the left side of the toolbar and drag it to where you want it located on the screen. Use the arrow buttons on the toolbar to pan or tilt the camera in the direction you want. The other controls on the toolbar perform as described below:

- Zoom In / Out
- Focus Near / Far
- Iris Open / Close
- Set / Load Preset
- Advanced PTZ

Event Monitoring

When an event occurs, the DVR will display the camera associated with the event and the icon displays on screen if Event Monitoring is selected in the Display setup screen (Primary Monitor tab).

How the cameras are displayed depends on the number of cameras associated with the event. If one camera is associated with the event, the DVR will display the camera full screen. If two to four cameras are associated with the event, the DVR will display the cameras on a 2x2 screen. If five to nine cameras are associated with the event, the DVR will display the cameras on a 3x2 or 3x3 screen. If 10 or more cameras are associated with the event, the DVR will display the cameras on a 4x3 or 4x4 screen.

Event monitoring lasts for the dwell time set for event recording. After the dwell time has elapsed, the monitor returns to the previous screen unless another event has occurred. If you want to return to the live monitoring mode before the dwell time has elapsed, press the **MODE** button or one of the camera buttons.

Covert Camera

If a camera is set up as **Covert 1** in the Camera setup screen (General tab), that camera will not be displayed unless a user with **Covert Camera View** authority logs into the system. However the camera title and status icons will be displayed on the monitor.

If a camera is set up as **Covert 2** in the Camera setup screen (General tab), that camera appears to be **Off** unless a user with **Covert Camera View** authority logs into the system. The camera title will be grayed out and status icons will not be displayed on the monitor.

NOTE: When a camera is set up as Covert 1, the DVR displays the camera title and status icons on the covert video. When set up as Covert 2, the DVR displays only the camera title on the covert video.

If a user who has **Covert Camera View** authority logs into the system, the user can view video from cameras set to **Covert 1** or **Covert 2** including the camera titles and status icons.



NOTE: The covert camera function of network devices follows the settings you set in the network device not in the DVR.

Spot Monitoring

NOTE: Spot monitoring video from network devices will not be supported.

The multiview screen display (2x2, 3x3 or 4x4) and sequence monitoring is supported on a Spot Monitor. Selecting **Spot** after selecting  (Monitor) in the Live Monitoring menu allows you to control a Spot Monitor.

Select  (Display) → **Screen Format** in the Live Monitoring menu and then select the screen mode between 2x2, 3x3 and 4x4 you want to display on a Spot Monitor.

Selecting  (Sequence) in the Live Monitoring menu causes the cameras to display sequentially, and selecting  again stops sequencing on a Spot Monitor. Any cameras that are **Off**, have lost video or are set to **Covert** (unless the user has authority to view covert cameras) will be excluded from the sequence. When the Spot Monitor is in the sequence mode, you can set the camera's display dwell time. Refer to *Chapter 3 – Configuration – Display Setup* section for details.

NOTE: Sequence cannot be used in the 4x4 display mode of the 16-channel.

Recording Video

Once you have installed the DVR following the instructions in *Chapter 2 – Installation*, it is ready to record. The DVR will start recording based on the settings you made in the **Record** setup screen. See *Chapter 3 – Configuration*.

Recycle On or **Recycle Off**. The factory default is **Recycle On**. It does this by recording over the oldest video once the hard disk is full. Setting the DVR to **Recycle Off** causes it to stop recording once the hard disk is full.

NOTE: When recording video from network devices, the DVR has a recording speed of 120 ips with Standard image quality and a resolution setting of 1920x1080 for each channel. Depending on the DVR's operating situation and network environment, the recording speed of network devices might increase or decrease. This recording speed standard is based on 1-Gbps Ethernet when the DVR is only recording video from network devices, and the monitoring feature is not being used.

The recording speed (ips) and resolution for the network camera will follow the settings you set in the camera and not the settings in the DVR.

When the recording speed and resolution for the network video transmitter you set in the DVR are higher than the ones you set in the network video transmitter, the DVR will record video at the recording speed and resolution you set in the network video transmitter.

Although you will be able to record without changing the unit from its original factory settings, you will want to take advantages of the DVR's many tools. See *Chapter 3 – Configuration* for detailed descriptions of the recording mode options.

Panic Recording

Selecting **Panic** in the Live Monitoring menu or Search menu starts panic recording of all cameras. Selecting **Panic** again stops panic recording. If you set the Panic Recording Duration in the Panic Record setup screen, panic recording will stop automatically according to the preset duration as long as **Panic** is not selected.

NOTE: When the DVR is not in the Recycle mode and all available storage space has been used, panic recording will not operate.

Recording Audio

If the DVR was set up to record audio, it will record audio from up to four inputs when video is recording.

NOTE: Make certain you comply with all local and federal laws and regulations when recording audio.

Playing Recorded Video

If a user who has Search authority logs into the system, the user can view recorded image. Once video has been recorded, you can view it by pressing the **Play/Pause** button on the Record Table Search screen.

The DVR supports the Triplex function: monitoring, recording and playing back at the same time. Pressing the **PLAY/STOP** button when in one of the multi-view formats enters the Triplex mode and displays the Select Playback Camera menu.

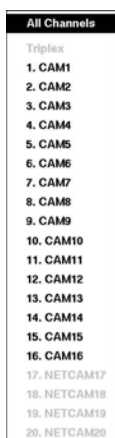

Selecting All Channels plays back video of all cameras. The DVR maintains the same display format as it does in the live mode except for the PIP format. You can also change the screen layout in the same way as you do in the live mode.

Selecting the camera number under Triplex enters the Triplex mode and plays back video of the selected camera. When in the single-screen display format, the camera currently displayed on the screen will be selected and when in the PIP display format, the camera displayed on the PIP screen will be selected for the search channel. During the Triplex mode, the DVR maintains the same display format as it does in the live mode. A red outline surrounding the video and the camera title indicates the search channel. While in the Triplex Mode, the DVR continues recording cameras as they were set up in the recording schedule. Also, live monitoring will continue except for the camera that has been selected for playback.

NOTE: While in the triplex mode, the playback speed might decrease when monitoring live video of network devices.

Figure 47 : Select Playback Camera menu.

When playing video for the first time, the DVR will display the most recent image. When playing video subsequent times, the DVR will start playing video from the last recalled image. Recorded audio will be played when the DVR displays a camera with recorded audio in full screen mode.

NOTE: Only the administrator and users with *Covert Camera View* authority can view video from covert cameras. The covert cameras in the playback mode are determined by the current camera settings.

Camera Buttons (1 to 16): Pressing the individual camera buttons will cause the selected camera to display full screen.

Arrow Buttons: In the playback mode, pressing the Left arrow button plays video backward at high speed. Pressing the button again toggles the playback speed from **◀◀**, **◀◀◀** and **◀◀◀◀**. The screen displays **◀◀**, **◀◀◀** and **◀◀◀◀** respectively. Pressing the Right arrow button plays video forward at high speed. Pressing the button again toggles the playback speed from **▶▶**, **▶▶▶** and **▶▶▶▶**. The screen displays **▶▶**, **▶▶▶** and **▶▶▶▶** respectively.

Jog Dial, Shuttle Ring

- **Jog Dial:** The Jog Dial only functions when playback video has been paused. By turning the jog dial clockwise, you can play video forward image-by-image. By turning the jog dial counterclockwise, you play video backward image-by-image.
- **Shuttle Ring:** The Shuttle Ring only functions in the Playback mode. The Shuttle Ring is spring loaded and returns to the center position when released. Turning the ring clockwise plays video forward. Turning the ring counterclockwise plays video backward. Playback speed varies with the amount the ring is turned. The playback speeds are ◀◀, ◀◀◀, ◀◀◀◀, ▶x0.5, ▶, ▶▶, ▶▶▶ and ▶▶▶▶. When you release the ring, it snaps back to the center position and the video pauses.

Mode Button: Pressing the **MODE** button toggles different display formats. The available formats are: PIP, 2x2, 3x2, 3x3, 4x3, 4x4 and 5x4.

You can use a mouse for convenient playback control. Position the mouse pointer on the playback screen, and the following Record Table Search (Compact View Mode) screen will display. The individual controls on the toolbar perform the following functions as described below:



- | | | |
|--------------------------|-------------------|----------------------|
| Go to the previous image | Play/Pause | Go to the next image |
| Fast backward play | Fast forward play | |

Searching Video

While in the search mode, pressing the **MENU** button displays the following Search menu to the right edge of the screen. Pressing the **ESC** button hides the menu. You can navigate through menus and items by pressing the arrow buttons.







Figure 48 : Search menu.

- | | | | | |
|----------|---------------|-----------|---------------|---------------------|
| ① Search | ② Go To | ③ Display | ④ Alarm | ⑤ Digital Deterrent |
| ⑥ Panic | ⑦ Camera menu | ⑧ Export | ⑨ Data Source | ⑩ Exit |



NOTE: The Search menu also can be displayed by moving the mouse pointer to the right edge of the screen.

Search Menu

Search



- **Event Log Search:** Selecting  (Search) → Event Log Search selects video from the event log. See the following *Event Log Search* section for details.
- **Record Table Search:** Selecting  (Search) → Record Table Search selects using a recording table. See the following *Record Table Search* section for details.
- **Motion Search:** Selecting  (Search) → Motion Search selects motion events. See the following *Motion Search* section for details.
- **Text-In Search:** Selecting  (Search) → Text-In Search selects text input strings. See the following *Text-In Search* section for details.
- **EZ Search:** Selecting  (Search) → EZ Search selects video in 4x4 display format using day, hour or minute precision. See the following *EZ Search* section for details.

Go To

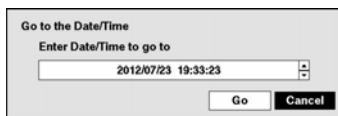
- **Go to the First:** Selecting  (Go To) → Go to the First displays the first recorded image.
- **Go to the Last:** Selecting  (Go To) → Go to the Last displays the last recorded image.
- **Go to the Date/Time:** Selecting  (Go To) → Go to the Date/Time displays the Go to the Date/Time screen.







Move the cursor over the date and time and press the  button. You can use the Left and Right arrow buttons to highlight the year, month, day, hours, minutes and seconds. Use the Up and Down arrow buttons to change to the date and time you want to search for video.

Once you have set the date and time you want, press the  button. Then highlight **Go** and press the  button. The selected date and time will display. (If no video was recorded during the selected time, a message appears alerting you that no image was recorded at that time.) The playback controls on the Record Table Search screen, and Jog and Shuttle on the front panel can now be used to review the surrounding video.

- **Bookmark:** Selecting  (Go To) → Bookmark adds the current playback point to the bookmark list. See the following *Bookmarks* section for details.

Display

- **Camera:** Selecting  (Display) → Camera and choosing the camera number displays the selected camera full screen. It is the same as pressing the individual camera buttons on the front panel or clicking the left mouse button on a camera image when in one of the multiview formats (i.e., PIP, 2x2, 3x2, 3x3, 4x3, 4x4 or 5x4). Clicking the left mouse button on the screen again returns to the previous display mode.
- **Screen Format:** Selecting  (Display) → Screen Format and choosing the screen mode displays the cameras in the selected multiview screen mode (PIP, 2x2, 3x2, 3x3, 4x3, 4x4 or 5x4). Selecting each display mode is the same as pressing the **MODE** button or scrolling the mouse wheel up and down when in one of the multiview formats.
- **Previous Group, Next Group:** Selecting  (Display) → Previous Group or Next Group moves to the previous or next page.
- **Edit Group:** Selecting  (Display) → Edit Group enters to the Active Cameo mode. Refer to the previous *Live Monitoring – Active Cameo Mode* section for details.
- **Camera OSD, Status OSD:** Selecting  (Display) → Camera OSD or Status OSD toggles Camera OSD or Status OSD On and Off.

Alarm

Selecting  (Alarm) in the Search menu resets the DVR's outputs including the internal buzzer during an alarm. It is the same as pressing the **ALARM** button.



Digital Deterrent

Selecting  (Digital Deterrent) in the Search menu displays the following setup screen and allows the DVR to play manually.





Highlight the box beside **Source name** and press the  button to select the source file to play. Highlighting **Trigger** plays the selected file as the digital deterrent.

Panic





Selecting  (Panic) in the Search menu starts panic recording of all cameras, and selecting  again stops panic recording.

Camera Menu

- **Zoom:** Selecting  (Camera Menu) → **Zoom** and choosing the camera number zooms the current playback image of the selected camera on the screen.
- **Audio:** Selecting  (Camera Menu) → **Audio** toggles audio playback On and Off. Recorded audio will be played when the DVR displays a camera with recorded audio in full screen mode.
- **Show/Hide Text-In:** Selecting  (Camera Menu) → **Show Text-In** or **Hide Text-In** shows or hides the text-in data on the screen if the video was recorded with text-in data.

NOTE: The *Camera Menu* also can be displayed by clicking the right mouse button on the screen while in the search mode.

Export

- **EZ Copy:** Selecting  (Export) → **EZ Copy** will set the starting point of the video to be clip copied, and the  icon displays at the bottom-left corner of the screen. Selecting **EZ Copy** again will set the ending point of the video to be clip copied and displays the **Clip-Copy** screen. See the following *Clip Copy* section for details.
- **Clip-Copy:** Select  (Export) → **Clip-Copy**, and the **Clip-Copy** screen appears to allow clip copy setup. See the following *Clip Copy* section for details.
- **Digital Deterrent Recording:** Selecting  (Export) → **Digital Deterrent Recording** allows you to extract audio files from recorded audio on the DVR. Refer to *Chapter 3 – Configuration – Digital Deterrent* section for details
- **Print:** Selecting  (Export) → **Print** allows you to print a selected image. See the following *Print* section for details.

Data Source

Selecting  (Data Source) in the Search menu allows you to select the data source to be searched. Selecting **Record** searches recorded data on primary storage installed in the DVR, and selecting **Archive** searches archived data on secondary storage installed in the DVR.

Exit

Selecting  (Exit) in the Search menu exits the search mode and enters the live monitoring mode.

Event Log Search

Time	Type
2012/07/23 19:37:54	Panic On
2012/07/23 19:37:52	Video Loss 13: CAM13
2012/07/23 19:37:50	Video Loss 4: CAM4
2012/07/23 19:37:49	Video Loss 5: CAM5
2012/07/23 19:34:56	Video Loss 5: CAM5
2012/07/23 19:34:53	Video Loss 8: CAM8
2012/07/23 19:34:49	Video Loss 4: CAM4
2012/07/23 19:34:44	Panic On
2012/07/23 19:34:36	Video Loss 8: CAM8
2012/07/23 19:34:34	Video Loss 13: CAM13
2012/07/23 19:34:24	Panic On
2012/07/23 18:34:30	Fan Error
2012/07/23 18:29:07	Fan Error

Option... Close

Figure 49 : Event Log Search screen.

The DVR maintains a log of each time the Alarm Input port is activated. The Event Log Search screen displays this list. Use the arrow buttons to highlight the event for which you would like to see video.

The Event Log Search screen can also be accessed by pressing the **ALARM** button unless there is an alarm. There is no determined user authority to display the Event Log Search screen, however, the event video will not be played unless a user with Search authority logs into the system.

Pressing the **←** button will extract the event video and display the first image of the event. Pressing the **▶** (Play/Pause) button on the Record Table Search screen will start playing the “event” video segment. Pressing the **PLAY/STOP** button returns to live monitoring.

NOTE: It is possible that no recorded image displays on the current screen. Press the **MODE button and change the screen mode to 5x4. You will be able to easily see the camera have recorded video during target time.**

You can also narrow your event search by selecting the Option... button and setting up the new search condition.

Event Log Search Option

From First 10/31/2013 19:17:45

To Last 10/31/2013 19:17:45

Check Time Overlap

Alarm-In	1-20	<input checked="" type="checkbox"/> Panic Record
Motion	1-20	<input checked="" type="checkbox"/> Check Recording
Video Loss	1-20	<input checked="" type="checkbox"/> Check Alarm-In
Video Blind	1-20	<input checked="" type="checkbox"/> Disk Almost Full
Audio Detection	17-20	<input checked="" type="checkbox"/> Disk Bad
Trip-Zone	17-20	<input checked="" type="checkbox"/> Disk Temperature
Tampering	17-20	<input checked="" type="checkbox"/> Disk S.M.A.R.T.
Text-In	1-16	<input checked="" type="checkbox"/> Fan Error
Record Channels	1-20	<input checked="" type="checkbox"/> Disk Added/Removed
		<input checked="" type="checkbox"/> Disk Config Change

Search Cancel

You can search video from the first to last recorded images, or you can set the start and stop times and dates.

Highlight the box beside **From** and press the **←** button to toggle between On and Off. When set to Off, you can enter a specific Date and Time. When set to On, the search will be from the first recorded image.

Highlight the box beside **To** and press the **←** button to toggle between On and Off. When set to Off, you can enter a specific Date and Time. When set to On, the search will be to the last recorded image.

Highlight the box beside **Check Time Overlap** and press the  button. It toggles between On and Off. You will only be able to turn the Check Time Overlap on or off if a user-defined date and time is set to From and To. If the DVR's date and time have been reset, it is possible for the DVR to have more than one overlapping start and stop time. When set to On, you will be asked to select one of the overlapping start and stop time. When set to Off, the DVR will display search results from all start times to all stop times.

Highlight the box beside **Alarm-In** and press the  button. You can select the alarm inputs that you want to include in your search.

Highlight the box beside **Motion** and press the  button. You can select the cameras for which you want any reports of motion detection.

Highlight the box beside **Video Loss** and press the  button. You can select the cameras for which you want any reports of lost video.

Highlight the box beside **Video Blind** and press the  button. You can select the cameras for which you want any reports of blind video.

Highlight the box beside **Audio Detection** and press the  button. You can select the cameras for which you want any reports of audio input. (Network Devices Only)

Highlight the box beside **Trip-Zone** and press the  button. You can select the cameras for which you want any reports of trip-zone. (Network Devices Only)

Highlight the box beside **Tampering** and press the  button. You can select the cameras for which you want any reports of tampering. (Network Devices Only)

Highlight the box beside **Text-In** and press the  button. You can select the text-in devices which you want any reports of text input.

Highlight the box beside **Record Channels** and press the  button. You can select the cameras that you want to search for any reports of event recorded data. The DVR will display the events (not the camera channels) that occurred and that also are recorded on the camera channel that you selected. If you do not select a camera channel in this field, the DVR will search events that are not associated with cameras.

You can also toggle On and Off self-diagnostic System Events as part of your search. The choices are:

- Panic Record
- Check Recording
- Check Alarm-In
- Disk Almost Full
- Disk Bad
- Disk Temperature
- Disk S.M.A.R.T.
- Fan Error
- Disk Added/Removed
- Disk Config Change

Once you set your desired search conditions, highlight **Search** and press the  button to display the search results in the **Event Log Search** screen. Selecting **Cancel** exits the screen without saving the changes.

Record Table Search

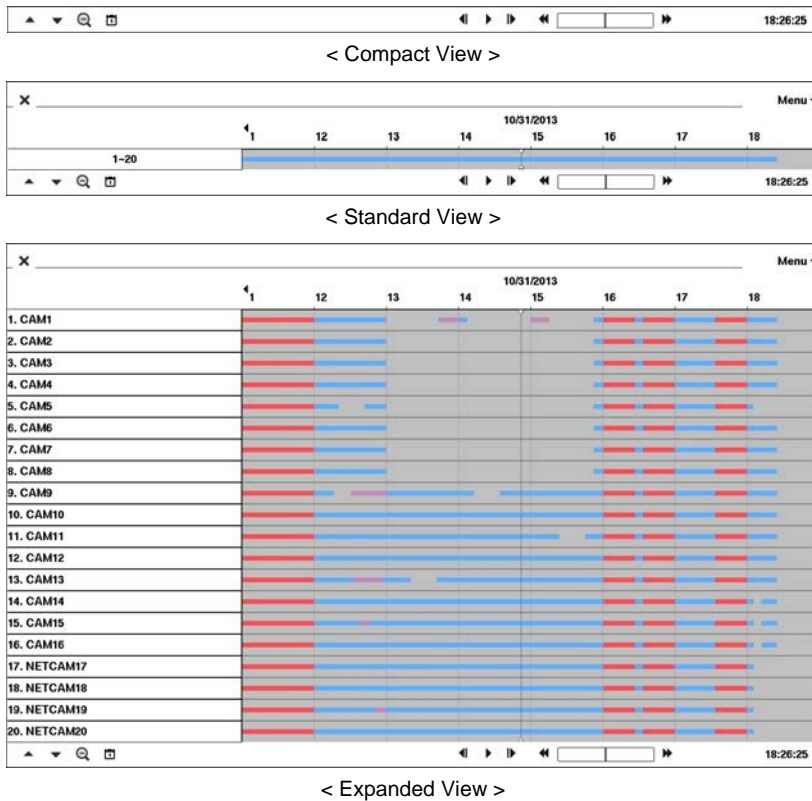

Figure 50 : Record Table Search screen.

Recording information about video images currently displayed on the screen displays on the recording status bar. A grey vertical line indicates the current search position. To search specific video, move the vertical line by using the Left or Right arrow buttons on the front panel or by clicking the mouse on the desired segment.

If the DVR's time and date have been reset to a time that is earlier than some recorded video, it is possible for the DVR to have more than one video stream in the same time range. In this case, the overlapping time range in the record table will be separated by a yellow vertical line.

NOTE: The recorded data in the time range located after the white vertical line is the latest.

There are three view modes. Standard view, Expanded view and Compact view. Standard view (default) displays combined recording information of all camera channels currently displayed on the screen. In the Standard view mode, selecting the ▲ icon located at the bottom switches to the Expanded view mode. The Expanded view displays the recording information of each camera channel currently displayed on the screen. Selecting the ▼ icon in the Standard view mode switches to the Compact view mode which displays only the toolbar. Selecting the ▲ icon in the Compact view mode switches to the Standard view mode, and selecting the ▼ icon in the Expanded view mode switches to the Standard view mode.

Selecting 🔍 or 🔍 located at the bottom zooms the record table. Selecting 🔍 displays eight hours (1-minute based), and selecting 🔍 displays 24 hours (3-minute based) at once. To move to earlier or later times that are not shown in the current record table screen, select the arrows located at the end of the times by using the arrow buttons on the front panel.

NOTE: If the DVR has images recorded in more than one recording mode in the same time range, the recording status bar displays recording information in the following priority order: Panic → Pre-Event → Event → Time → Irregular (Irregular recording caused by temporary disconnection from the network device). The color of the bar indicates different recording modes: Red for Panic, Yellow for Pre-Event, Purple for Event, and Blue for Time.

Selecting  located at the bottom displays the Calendar Search screen.







Days with recorded video display on the calendar with white numbers. You can highlight the days with recorded video by using the arrow buttons. Once you have highlighted a day, press the  button to select it. The first recorded image of the selected date will pause on the screen. Once you have selected the date you want to search, review the surrounding video by using the playback controls located at the bottom of the Record Table Search screen.

Selecting Menu in the top-right corner displays the Search menu.



- **Go To:** Displays the first or last recorded image, searches by date and time, or adds the current playback point to the bookmark list (see the previous *Searching Video – Go To* and *Bookmarks* sections of this chapter for more details).
- **Clip-Copy:** Clips a video segment and saves it (see the following *Clip Copy* section for more details).
- **Print:** Prints the current playback image.
- **Digital Deterrent Record:** Extracts audio files from recorded audio on the DVR see *Chapter 3 – Configuration – Digital Deterrent* section for more details).
- **Zoom:** Zooms the current playback image.
- **Slow Play:** Plays video at low speed (x1/2, x1/3, x1/4, x1/6 and x1/8).

The individual playback controls at the bottom perform the following functions as described below:

-  Go to the previous image
-  Play/Pause
-  Go to the next image
-  Fast backward play
-  Fast forward play

Selecting  in the top-left corner exits the Record Table Search screen.

Motion Search

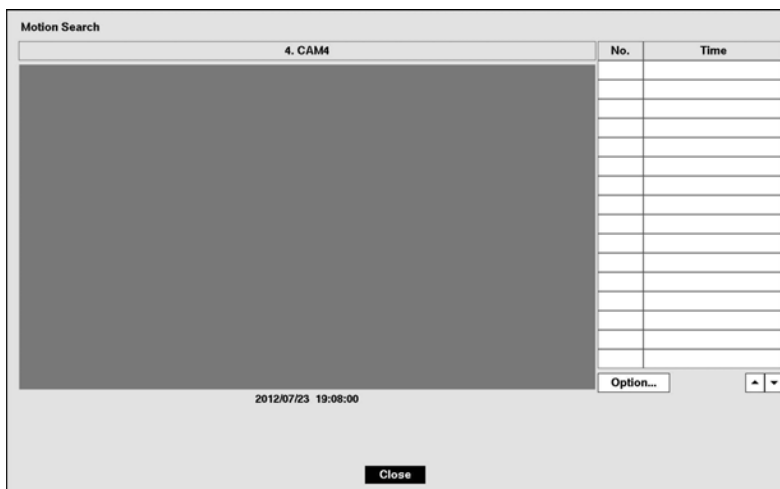

Figure 51 : Motion Search screen.

The **Motion Search...** can be selected from the Search menu while the DVR displays the camera full screen. The Motion Search screen displays a list of motion events. Use the arrow buttons to highlight the event for which you would like to see video and press the **←** button to display the video associated with the selected event on the small search screen.

Highlighting **Close** and pressing the **←** button will extract the video associated with the Motion event and display the first image of the event. Pressing the **▶** (Play/Pause) button on the Record Table Search screen will start playing the “event” video segment. Pressing the **PLAY/STOP** button returns to live monitoring.

You can also narrow your event search by selecting the **Option...** button and setting up the new search condition.

You can search video from the first to last recorded images, or you can set the start and stop times and dates.

Highlight the box beside **From** and press the **←** button to toggle between On and Off. When set to Off, you can enter a specific Date and Time. When set to On, the search will be from the first recorded image.

Highlight the box beside **To** and press the **←** button to toggle between On and Off. When set to Off, you can enter a specific Date and Time. When set to On, the search will be to the last recorded image.

Highlight the box beside **Type** and press the **←** button. You can select between Motion Search and Museum Search. Motion Search detects motion in the defined area. Museum Search detects if a defined object has moved.

Highlight the box beside **Zone** and press the **←** button. An image from the video appears with a grid overlaid. You can turn sensor blocks On and Off to define the area of the picture in which you want to search for motion.

NOTE: Defining the area of the image in which you want to search for motion is nearly identical to setting up the DVR for Motion Detection. Please refer to *Motion Setup Screen* in *Chapter 3 — Configuration* for more detailed instructions on setting up the detection blocks.

When setting the Museum Search Zone, the zone should be placed inside of the border line of the target object. If the selected block is placed on the border line, the sensitivity of the Museum Search may decrease.

The zone should be placed or focused on the centre or, at least, within the outline of targeted object.

Highlight the box beside **Sensitivity** and press the **←** button. You will be able to select from 1 (low sensitivity) to 5 (high sensitivity).

Highlight the box beside **Min. Blocks** and press the **←** button. You will be able to set the number of sensor blocks that must be activated. Setting the Min Blocks will only be available if Motion Search is selected.

Once you set your desired search conditions, highlight **Search** and press the **←** button to display the search results in the Motion Search screen. Selecting **Cancel** exits the screen without saving the changes.

When you search for motion events of another camera, you will be asked whether or not you want to delete the previous search results from the list.

Text-In Search



Figure 52 : Text-In Search screen.

The DVR maintains a log of each time there is Text Input. The Text-In Search screen displays this list. Use the arrow buttons to highlight the event for which you would like to see video.

Pressing the button will extract the video associated with the Text Input and display the first image of the event. Pressing the (Play/Pause) button on the Record Table Search screen will start playing the “event” video segment. Pressing the button returns to live monitoring.

NOTE: It is possible that no recorded image displays on the current screen. Press the button and change the screen mode to 5x4. You will be able to easily see the camera have recorded video during target time.

Text Input information will be overlaid on the image while the recorded video is played at regular speed.

You can also narrow your event search by selecting the Option... button and setting up the new search condition.

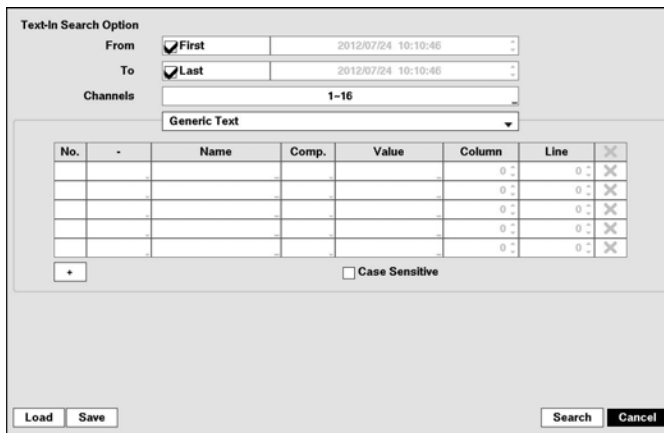

You can search video from the first to last recorded images, or you can set the start and stop times and dates.

Highlight the box beside From and press the button to toggle between On and Off. When set to Off, you can enter a specific Date and Time. When set to On, the search will be from the first recorded image.

Highlight the box beside To and press the button to toggle between On and Off. When set to Off, you can enter a specific Date and Time. When set to On, the search will be to the last recorded image.

Highlight the Channel and press the button. Select the text-in devices that you want to search for text input.

Highlight the Text Input Device box and press the  button. Select your Text Input Device from the list.

Highlighting the + and pressing the  button allows you to add a new set of search parameter. Set up the desired search parameter. Refer to the *Appendix – Text-In Search Examples* for further information on setting up search parameters. The **X** column can be used to delete a set of search parameter or entire sets of search parameters.





Highlight Case Sensitive and press the  button. This will toggle between On and Off. When this feature is On, the search will find only those text strings in which the case matches.



Highlight Load and press the  button to load saved search option settings. Select the desired search option settings.

Highlight Save and press the  button to save the current search option settings. A virtual keyboard appears that you can use to enter the search option name.

Once you set your desired search conditions, highlight Search and press the  button to display the search results in the Text-In Search screen. Selecting Cancel exits the screen without saving the changes.



EZ Search

You can enter the EZ Search mode by selecting  (Search) → EZ Search in the Search menu while the DVR displays the camera full screen. When entering the EZ Search mode, the DVR will play video in 4x4 display format starting with the first recorded image using the Day precision (default). There are three precision levels: Day, Hour and Minute. Exit the EZ Search mode by pressing the  button or selecting  (Exit) in the EZ Search menu displayed when pressing the  button.

While in the EZ Search mode, selecting  (Precision) from the EZ Search menu, displayed when pressing the  button, displays the following Precision Menu.

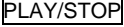

Precision
Previous Precision
Next Precision
Search Forward
Search Backward

- **Previous Precision:** Selecting Previous Precision moves to the previous precision level starting with the window currently selected on the screen (Day → Minute → Hour → Day → ...). It is the same as pressing the  button on the front panel when in the EZ Search mode.
- **Next Precision:** Selecting Next Precision moves to the next precision level starting with the window currently selected on the screen (Day → Hour → Minute → Day → ...). It is the same as pressing the  button on the front panel when in the EZ Search mode.
- **Search Forward:** Selecting Search Forward moves to the next page while maintaining the current precision level.
- **Search Backward:** Selecting Search Backward moves to the previous page while maintaining the current precision level.

While in the EZ Search mode, pressing the  button displays the EZ Search menu. Select  (Go to) from the EZ Search menu to display the following Go to Menu.

GO TO
Go to the First
Select from the Calendar

- **Go to the First:** Selecting Go to the First displays video using day precision starting with the first recorded image.
- **Select from the Calendar:** Selecting Select from the Calendar displays video using day precision starting with the date selected on the Calendar.

In the EZ Search mode, pressing the camera number button on the front panel displays video starting with that window number using the current precision setting. Arrow buttons on the front panel are used to navigate through windows and pressing the  button moves to the next precision level starting with the selected window. When in the Minute precision mode, pressing the  button exits the EZ Search mode and displays the selected window full screen.

NOTE: While in the Day precision mode, “...” after the date information displayed on the camera screen indicates that the DVR has more than one video stream for the same date. Selecting the window and pressing the  button allows you to select the video stream you want to search and move to the next precision level. The highest Segment number indicates the latest video.

Bookmarks

The Bookmarks screen can also be accessed by selecting **Bookmark** in the Search – Go To menu.

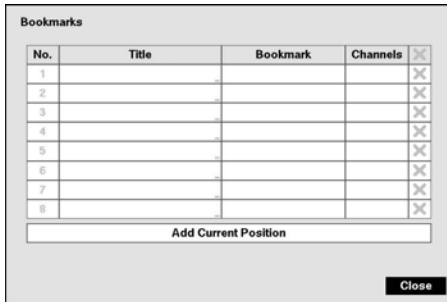

Highlight the **Add Current Position** box and press the **←** button to add the current playback point to the bookmark list. Highlight the **Title** box and enter the name of the registered bookmark. Use the virtual keyboard to enter the bookmark name.

NOTE: Up to eight bookmarks can be registered.

Use the arrow buttons to highlight the bookmark point for which you would like to see video. The selected bookmark will display on the screen. The playback controls on the Record Table Search screen, and Jog and Shuttle on the front panel can now be used to review the surrounding video.

Figure 53 : Bookmarks screen.

Clip-Copy

Video clips can be copied on an internal DVD RW drive, or external USB hard disk or flash drive. The copied video clips can be viewed on computers running Microsoft Windows 2000, XP, Vista or 7. Refer to the *Appendix – USB Hard Disk Drive Preparation* for information on preparing the external drive for clip copy.

Selecting **EZ Copy** in the Search – Export menu or pressing the **COPY** button during playback will set the starting point of the video to be clip copied, and the **⏮** icon displays at the bottom-left corner of the screen. Selecting **EZ Copy** in the Search – Export menu or pressing the **COPY** button again will set the ending point of the video to be clip copied by displaying the Clip-Copy screen.

Pressing and holding the **COPY** button for more than three seconds while in the Search mode initiates the One-Touch Clip Copy function. The last recorded image will be the ending point of video to be clip copied, and the system will automatically begin to calculate the possible video data size that the selected storage media can handle.

Select **Clip-Copy** in the Search – Export menu, and the **Clip-Copy** screen appears to allow clip copy setup.

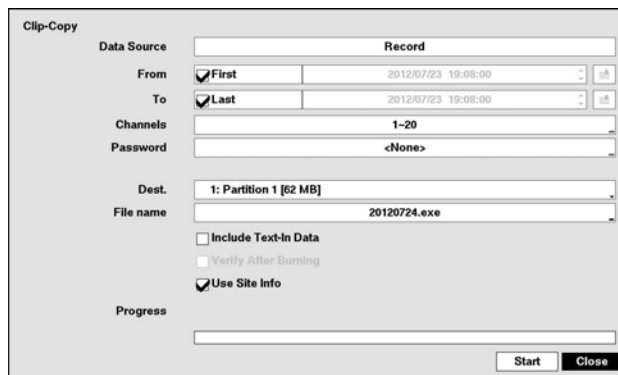









Figure 54 : Clip-Copy screen.

The **Data Source** box displays the source from which you make a video clip copy. The data source can be selected from **Record** or **Archive** in the Search menu.

You can search video from the first to last recorded images, or you can set the start and stop times and dates.

Highlight the box beside **From** and press the  button to toggle between On and Off. When set to Off, you can enter a specific Date and Time. When set to On, the search will be from the first recorded image. When highlighting  and pressing the  button the bookmark list displays and the bookmark point you selected will be the starting date and time.

Highlight the box beside **To** and press the  button to toggle between On and Off. When set to Off, you can enter a specific Date and Time. When set to On, the search will be to the last recorded image. When highlighting  and pressing the  button the bookmark list displays and the bookmark point you selected will be the ending date and time.

Highlight the box beside **Channels** and press the  button. You can select the cameras that you would like to include in your video clip.

NOTE: The channel numbers 1 to 16 are local camera channels and 17 to 20 are network device channels.

Highlight the box beside **Password** and press the  button. A virtual keyboard appears allowing you to enter the password for reviewing the video clips.

Highlight the box beside **Dest.** and press the  button. You can select the storage device on which you would like to record the video clip. You can choose from Internal DVD RW and USB Storage.

CAUTION: The USB device for clip copy must be FAT 16 or FAT32 format.

NOTE: While copying video clips on the DVD RW, the recording speed might decrease.

When the error message “Firmware update of the optical drive is required” displays, update the firmware of the installed DVD RW drive. Please follow the instructions described in *Chapter 3 – Configuration – System Setup* section.

The DVR automatically assigns a file name to the video clip. However, you can give the video clip file a different name. Highlight the box beside **File Name** and press the  button. A virtual keyboard appears. Enter a file name for the video you are backing up and select **Close**. The DVR will automatically add the camera number (for example “01”) and “.exe” to the file name.



NOTE: When naming a file, you cannot use the following characters: \, /, :, ;, *, ?, !, “, <, >, |.

Highlight **Include Text-In Data** and press the  button. This will toggle between On and Off. When this feature is On, you can include text-in data when copying video if the video was recorded with text-in data.

Highlight **Verify After Burning** and press the  button. This will toggle between On and Off. When this feature is On, you can verify that the data is written on the DVD RW properly.

Highlight **Use Site Info** and press the  button. This will toggle between On and Off. When this feature is On, you can add the site name to the file name for the video you are backing up.

NOTE: When the site name is added to the file name, some special characters (\, /, :, ;, *, ?, !, “, <, >, |) in the site name will be converted to “_”.

Once you have given the video clip a file name, highlight the **Start** button and press the  button. The confirmation screen displaying data size will appear. When the storage device does not have enough space, the DVR will ask if you want to copy as much of the video clip as possible in the available space. Highlight the **Continue** button and press the  button to continue clip copy.

Once the clip copy starts, you can cancel it by selecting **Cancel** or hide the screen by selecting **Close**. When selecting **Close**, Clip Copy continues and a confirmation screen will display when complete.

NOTE: Only 4.7GB DVD media is available. To clip copy video on DVD media using remaining space, the size of previously recorded data on the DVD media should be less than 4GB.

Select the Full Erase option when erasing recorded data on DVD media, otherwise the media will not operate properly when rewritten.

The file size for clip copy is limited to 30GB. When copying video clips larger than 2GB, the video clips will be save in units of 2GB. For example, 3 individual 2GB files will be created when saving a 6GB video clip. However, the file size for the One-Touch Clip Copy is limited to 2GB.

You can use other functions on the DVR while video is being backed up. To do this, highlight the **Close** button and press the  button. You can return to the Clip-Copy screen at any time to check the progress.

You do not need to install any special software on your personal computer to review the video clips. Refer to Speco Central Operation Instruction for instructions on how to review video clips you have copied.

NOTE: During Clip Copy, you cannot shut the system down, clear data on the storage device, or format the storage device.

CAUTION: Do NOT disconnect the USB cable or the power from the external drive while copying video clips. If the external drive is shut down or the USB cable is disconnected while copying video clips, THE DVR SYSTEM MAY NOT WORK NORMALLY OR THE EXTERNAL DRIVE COULD BE DAMAGED, and you will get an error message the next time you try to copy video clips. You will need to power down the DVR and restart it to get rid of the error message. Once the file system of the USB hard disk drive has been corrupted, this error message cannot be dismissed. Even after restarting the DVR it may automatically restart while preparing to clip copy. You must recover the file system using the recovery program, or you must reformat the hard disk drive.

Print

You can print images on a printer. Connect a PostScript™ printer, or external hard disk drive or flash drive to one of the USB ports.

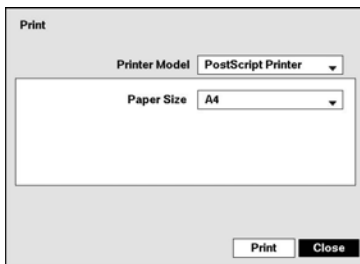

Highlight the box beside Printer Model and press the button. Selecting PostScript Printer will print images on a PostScript™ printer connected to the DVR. Selecting File Printer will save the current image as a PDF file on an external USB hard disk drive or flash drive.

NOTE: Images saved as PDF files can be printed on any printer connected to your PC.

Highlight the box beside Paper Size and press the button. You can select the paper size.

Figure 55 : Print screen.

Once you have selected the printer model and paper size, highlight the Print button and press the button. A message appears asking you if you want to print the current image. Highlight the Continue button and press the button to print.

NOTE: If your printer only supports an LPT connection (parallel), use an LPT to USB converter cable. The printer cable is not provided.

Disk Mirroring

The DVR supports disk mirroring to prevent unexpected loss of recorded video data that might be caused by disk damage or corruption. You can set up disk mirroring by highlighting Storage in the System menu and pressing the button.

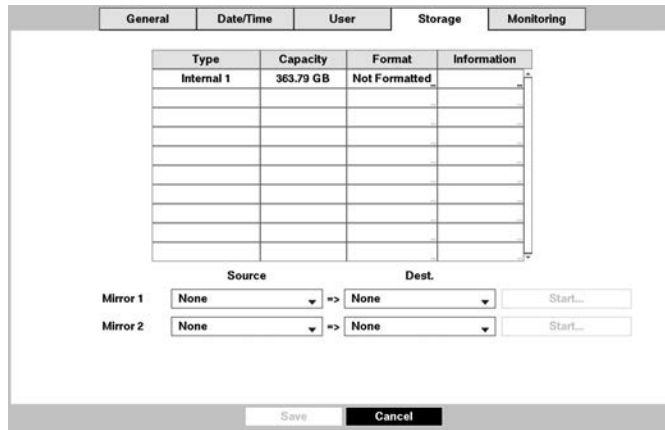



Figure 56 : System – Storage setup screen.

You can enable mirroring between two disks by designating the source disk and the destination disk from a list of internal hard disk drives. Up to two Mirrors are supported.

Highlighting the boxes under **Source** and **Dest.** and pressing the  button allows you to select the source disk and the destination disk for the selected Mirror.

NOTE: The source disk can be designated only from devices formatted for recording.

A device formatted for archiving cannot be used for disk mirroring.

The capacity of the destination disk should be the same or higher than the source disk for proper mirroring between the two disks.

CAUTION: Any existing data on the Destination Disk will be erased once it is designated as a mirror destination disk.

Highlighting **Start** and pressing the  button displays a confirmation screen asking you to confirm whether or not you want to start mirroring the selected disk. Once you start mirroring, the two disks will be resynchronized. Any data on the destination disk will be erased, and the data on the source disk will be copied to the destination disk. If the source disk is formatted and has no data, the disks will not be resynchronized. Resynchronization takes about 40 minutes per each 10GB of capacity. After resynchronization is complete, disk mirroring (writing data on the two disks at the same time) will start.

Once disk mirroring starts, you can cancel it by highlighting **Stop** and pressing the  button. Selecting **Stop** displays a confirmation screen asking you to confirm whether or not you want to stop mirroring for the selected disk.

NOTE: Once disk mirroring stopped, the destination disk will be set to *Not Used*. If resynchronization has been finished, the destination disk cannot be used for recording or archiving, but it can be used for searching. If you want to use the disk for recording or archiving, you must reformat it.

CAUTION: Disk mirroring will NOT automatically restart from an interrupted state. Once mirroring is stopped, you must restart it by following the mirroring setup procedures.

CAUTION: If disk mirroring fails, you must restart the system before trying disk mirroring again. When a disk mirroring failure is caused by a disk error, you must replace the disk with a new one.

Appendix

USB Hard Disk Drive Preparation

NOTE: The following description is for preparing a USB hard disk drive under Windows 2000. Preparing a USB hard disk drive under Windows XP, Window Vista and Window 7 is almost identical to Windows 2000.

1. Connect the USB hard disk drive to your computer using the USB Cable.
2. Turn on your computer.
3. The USB device icon should display on the Taskbar.
4. If the USB hard disk drive is partitioned or has data, it will show up in *My Computer* as a hard disk drive icon. Check the file system by right clicking on the icon and checking under *Properties > General > File System*. If the file system is NOT FAT32 format, format the USB hard disk drive using the FAT32 format.
5. If the USB hard disk drive is not partitioned, go to *Administrative Tools* in *Control Panel* and launch *Computer Management*. Open *Disk Management* in *Storage* and right click an unallocated region of the USB hard disk drive. Then, click *Create Partition*.
6. In the *Create Partition* wizard, click *Next* then *Primary Partition*, and follow the instructions on the screen. Make sure that the FAT32 is selected for the file system.

NOTE: The partition size should be less than 32GB because of Microsoft limitations.

After formatting is complete, the USB hard disk drive will be added to *My Computer*.

7. Connect the USB hard disk drive to the DVR.

Text-In Search Examples

Search Example I

1 2 3 4 5 6
123456789012345678901234567890123456789012345678901234567890

Item	Unit price	Qty	amount
Coke	\$ 2.20	1(s)	\$ 2.20
Fanta	\$ 2.20	1(s)	\$ 2.20
Hotdog	\$ 3.50	3(s)	\$ 10.50
Pepsi	\$ 1.95	1(s)	\$ 1.95
total : \$			16.85

Thank you~~

In the above text-in data, you can find that the comparison value is located at 17th (Unit price, \$ mark will be ignored automatically), 28th (Qty) and 40th (amount) characters (including spaces) from the left. In this case, you can enter "17", "28" and "40" in each Column box.

For example, if you want to search for Coke with a Qty (Quantity) of more than 1 and Hotdog with an amount totaling over \$8, the following search condition can be set.

Text-In Search Option

From First 2012/07/24 10:12:28

To Last 2012/07/24 10:12:28

Channels 1-16

Generic Text

No.	-	Name	Comp.	Value	Column	Line	X
1		Coke	>	1	28	0	X
2	AND	Hotdog	>	8	40	0	X
						0	X
						0	X
						0	X
						0	X

Case Sensitive

Load Save Search Cancel

Search Example II

1 2 3 4 5 6
 12345678901234567890123456789012345678901234567890

Item	Unit price	Qty	amount
Coke	\$ 2.20	1(s)	\$ 2.20
Fanta	\$ 2.20	1(s)	\$ 2.20
Hotdog	\$ 3.50	3(s)	\$ 10.50
Pepsi	\$ 1.95	1(s)	\$ 1.95
total :			\$ 16.85

Thank you~~

In the above text-in data, you can find that the comparison value is located at 17th (Unit price, \$ mark will be ignored automatically), 28th (Qty) and 40th (amount) characters (including spaces) from the left, but the value of amount category is located on a different line from Item. In this case, you can enter "17", "28" and "40" in each Column box and enter "1" in the Line box for the next line.

For example, if you want to search for Coke with a Qty (Quantity) of more than 1 and Hotdog with an amount totaling over \$8, the following search condition can be set.

Text-In Search Option

From First 2012/07/24 10:12:28

To Last 2012/07/24 10:12:28

Channels 1-16

Generic Text

No.	-	Name	Comp.	Value	Column	Line	X
1		Coke	>	1	28	0	X
2	AND	Hotdog	>	8	40	1	X
						0	X
						0	X
						0	X
						0	X

Case Sensitive

Load Save Search Cancel

Speco Remote

Speco Remote allows you to access a remote DVR, monitor live video images and search recorded video using Internet Explorer web browser anytime from virtually anywhere.

Computer system requirements for using the Speco Remote program are:

- Operating System: Microsoft® Windows® XP (Service Pack 3), Microsoft® Windows® Vista (Service Pack 1), Microsoft® Windows® 7 (Home Premium, Professional, Ultimate) or Microsoft® Windows® 8 (Pro, Enterprise)
- CPU: Intel Pentium III (Celeron) 600MHz or faster
- RAM: 128MB or higher
- VGA: 8MB or higher (1024x768, 24bpp or higher)
- Internet Explorer: Version 6.0 or later (32 Bit)

Start Internet Explorer on your local PC. You can run the Speco Remote program by entering the following information in the address field.

- “http://IP address:port number” (The DVR IP address and the Speco Remote port number (default: 12088) set in the Network setup screen (General tab))
- Or, “http://DVRNS server address/DVR name” (The DVRNS server address and the DVR name registered on the DVRNS server)

NOTE: You will need to get the appropriate IP address for the DVR you want to connect to and the Speco Remote port number from your network administrator.

Speco Remote only works with Microsoft Internet Explorer and will NOT work with other browsers.

Speco Remote does not work in Microsoft® Windows® 8 metro UI.



Select between the Remote Watch (Web monitoring) and Remote Search (Web search) modes. Entering ID and PASSWORD and clicking the [LOGIN] button logs in using the selected mode.

NOTE: Do NOT close the LOGIN window during the Speco Remote operation, otherwise, it will cause a script error when switching between Web monitoring and Web search modes, and you will need to restart the Speco Remote program.

When running the updated Speco Remote for the first time, Internet Explorer might occasionally load the information of the previous version. In this case, delete the temporary internet files by selecting Tools → Internet Options → General tab, and then run Speco Remote again.

There might be a problem that the bottom of Speco Remote page is cropped due to the address or status bars. In this situation, it is recommended that websites open windows without address or status bars by changing the internet setting. (Go to the Tools → Internet Options → Security tab → Click the Custom level... button → Select *Enable* for the *Allow websites to open windows without address or status bars* option)

When running Speco Remote in the Microsoft Windows Vista or higher operating system, it is recommended to start Internet Explorer with elevated administrator permissions. Click the right mouse button on the Internet Explorer icon and select the *Run as administrator* option from the context menu. Otherwise, some functions of the Speco Remote might be limited to use.

NOTE: There might be a problem with screen display or screen update due to low image transmission speed when using the Microsoft Windows Vista or higher operating system. In this situation, it is recommended that you disable the Auto Tuning capability of your computer.

Run the **Command Prompt** with elevated administrator permissions (Go to the Start Menu → Accessories → Command Prompt → Click the right mouse button and select the **Run as administrator** option). Then enter “netsh int tcp set global autotuninglevel=disable” and hit the enter key. Restart your computer to apply the changes.

If you want to enable the Auto Tuning capability again, enter “netsh int tcp set global autotuninglevel=normal” after running the Command Prompt with elevated administrator permissions. Restart your computer to apply the changes.



Web Monitoring Mode

Remote Watch is a remote web monitoring program that allows you to monitor live video transmitted in real-time from the remote DVR.



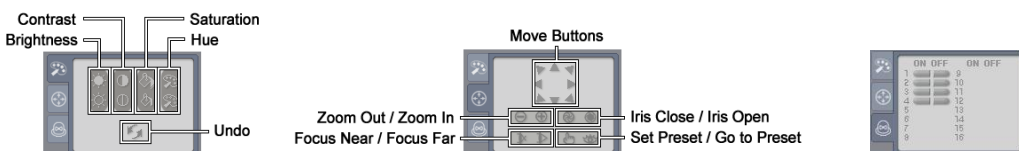



- ① Click the to log out the Speco Remote program.
- ② Click the to access to the web search mode.
- ③ Position the mouse pointer on the Remote Watch logo to see the version of the Speco Remote program.
- ④ The DVR information window displays the login information of Speco Remote.
- ⑤ Click the screen format to select the desired display mode. When changing the screen format, the selected camera on the current screen will be located in the first cell of the new layout.
- ⑥ Click the camera button to select the camera to be viewed.
- ⑦ Click the to adjust the brightness, contrast, saturation and hue of monitoring image.
- ⑧ Click the to control pan, tilt and zoom of the camera from a remote site.
- ⑨ Click the to control alarm out devices at the remote site.

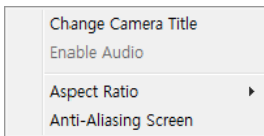

- ⑩ Click the  to set up the image drawing mode, OSD display and beep on/off. You can adjust the display speed by changing the image drawing mode, select OSD information to be displayed on the screen, and turn the DVR's internal buzzer on and off from a remote site.
- ⑪ Click the  to save the current image as a bitmap or JPEG file format.
- ⑫ Click the  to change the setup of the remote DVR.
- ⑬ The event status window at the bottom displays a list of events that were detected from the remote site.
- ⑭ Selecting a camera on the screen and clicking the right mouse button displays the text menu screen.



- **Change Camera Title:** Changes the camera name.
- **Enable Audio:** Enables audio communication with the remote site. When the audio control panel displays, click the  to send audio to the connected remote site and click the button again to stop sending audio. Click the  to monitor live audio from the connected remote site through the attached speaker and click the button again stop monitoring live audio. Clicking both  and  allows two-way communication. Clicking the  disables audio communication.
- **Aspect Ratio:** Changes the image aspect ratio.
- **Anti-Aliasing Screen:** Enhances image display quality by eliminating stair stepping (aliasing) effects in the enlarged image.

NOTE: A camera name change in the Remote Watch mode does not affect the camera name set up on the remote site. Leaving the Camera Title blank causes the camera name set up on the remote site to display.



The  icon will display on each camera screen when audio communication is available between the Speco Remote system and a DVR.

Web Search Mode

Remote Search is a remote web search program that allows you to search recorded video on the remote DVR.

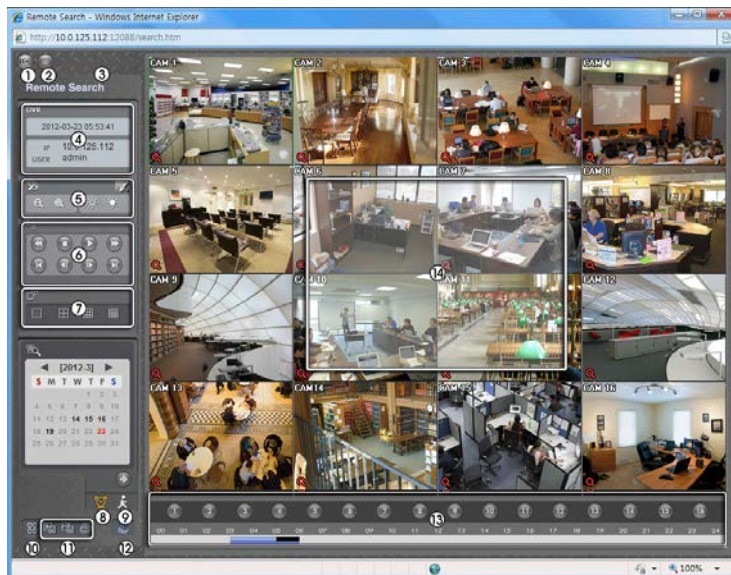
NOTE: The remote site connection in the Remote Search mode will automatically be disconnected if there is no activity for 30 minutes.



- ① Click the  to log out the Speco Remote program.
- ② Click the  to access to the web monitoring mode.
- ③ Position the mouse pointer on the Remote Search logo to see the version of the Speco Remote program..

- ④ The DVR information window displays the time information of recorded data on the remote DVR and login information of Speco Remote.
- ⑤ Click the to blur, sharpen, equalize and interpolate playback images. Click the to zoom out or zoom in the recorded image. Click the to adjust the brightness of the recorded images.



NOTE: Image processing works only in the pause mode.

- ⑥ The playback function buttons include fast backward, pause, play, fast forward, go to the first image, go to the previous image, go to the next image, and go to the last image.
- ⑦ Click the screen format to select the desired display mode.
- ⑧ Click the to enter the time-lapse search mode which allows you to search for recorded data by time and then play back images found within the time parameters. The Timetable window located at the bottom displays the time information for the image of the date selected on the calendar. If more than one video stream in the same time range, you can select the video stream you want to search. Clicking a specific time displays the image recorded at that time on the screen. Selecting the allows you to display an image from a specific time.
- ⑨ Click the to enter the event search mode which allows you to search for event log entries using specific conditions and play back the images associated with those event entries.
- ⑩ Click the to set up the image drawing mode and OSD display. You can adjust the display speed by changing the image drawing mode, and select OSD information to be displayed on the screen.
- ⑪ Click the to save any video clip of recorded data as an executable file, or click the to save the current image in a bitmap or JPEG file format. Click the to print the current image on a printer connected to your computer.
- ⑫ Click the to reload the recording data.
- ⑬ The Timetable displays recorded data of the selected camera by time (in hour segments).
- ⑭ Selecting a camera on the screen and clicking the right mouse button displays the text menu screen.

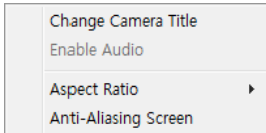
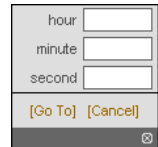

- **Change Camera Title:** Changes the camera name.
- **Enable Audio:** Plays audio while playing back recorded video that has recorded audio. (Single-Screen Layout Only)
- **Aspect Ratio:** Changes the image aspect ratio.
- **Anti-Aliasing Screen:** Enhances image display quality by eliminating stair stepping (aliasing) effects in the enlarged image.

NOTE: A camera name change in the Remote Search mode does not affect the camera name set up on the remote site. Leaving the Camera Title blank causes the camera name set up on the remote site to display.

Time Overlap

If the DVR's time and date have been reset to a time that is earlier than the existing recorded video, it is possible for the DVR to have more than one video stream in the same time range. In this case, you can search overlapping video streams individually by selecting a specific segment. For example, when the DVR has recorded video from one to five o'clock and the user changes the time backward from five to three o'clock and then continues recording until six o'clock, there will be two video streams and segments from three to five o'clock.

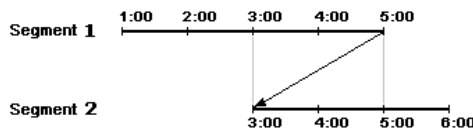

You can search overlapping video streams by selecting a specific time or time range. If you want to search recorded video at four o'clock during the overlapping time range using a search menu such as Go to the Date/Time, select the segment you want to search.



If you want to search recorded video from four to five o'clock during the overlapping time range using a search menu such as Event Log Search, Text-In Search or Motion Search, it is possible for the DVR to have two overlapping start and stop times. You will be asked to select one of the overlapping start and stop times from the search time ranges as follows:

- From four o'clock of the first segment to five o'clock of the first segment
- From four o'clock of the first segment to five o'clock of the second segment
- From four o'clock of the second segment to five o'clock of the second segment

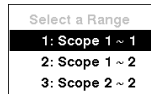

Remote Setup of Network Devices

The following describes how to set up the network devices using the ONVIF™ Conformance protocol on the DVR. While in the Live Monitoring mode, press the **MENU** button and move to the Camera menu and then to Network Camera setup. In the Network Camera setup screen, highlight the box under the Settings heading and press the **←** button.

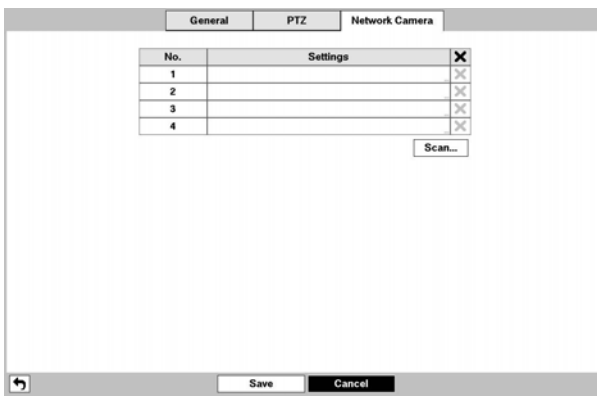

Highlight the Device Remote Setup box and press the **←** button. The Device Remote Setup screen appears.

NOTE: The setup menu and options may differ depending on the device model. Refer to the network device manufacturer's documentation for correct device settings.

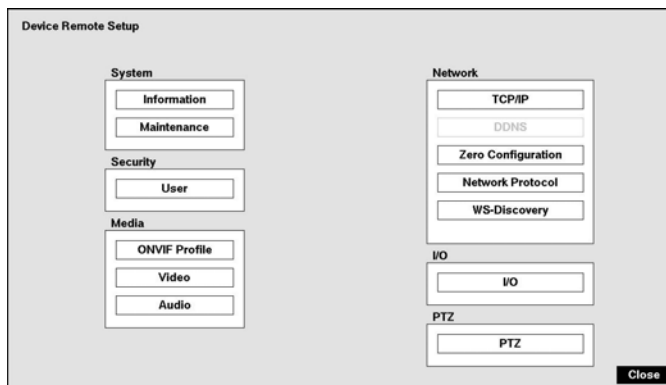

System Setup

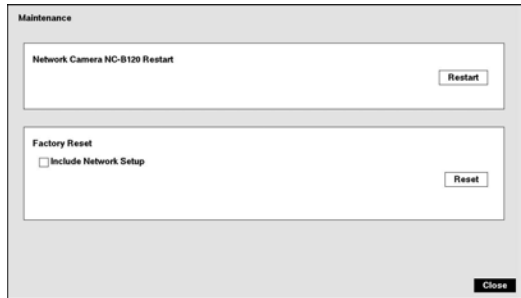

- Information: Displays the device information.
- Maintenance: Restarts the device or returns all device settings to the original factory settings.

Security Setup

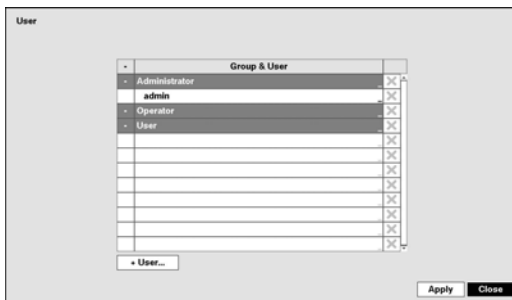

- User: Adds or deletes a user.

Media Setup

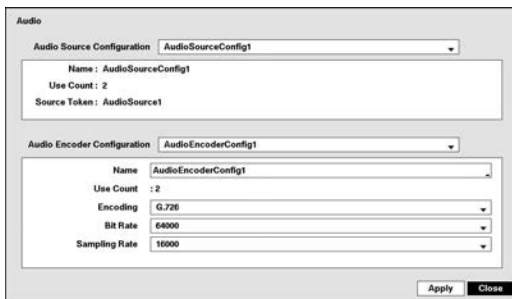
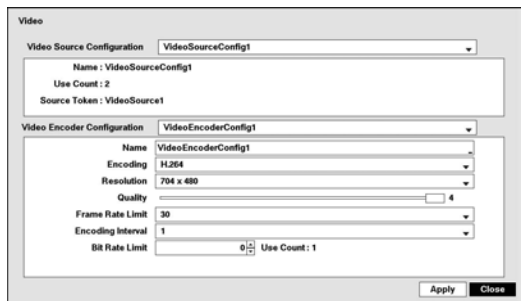
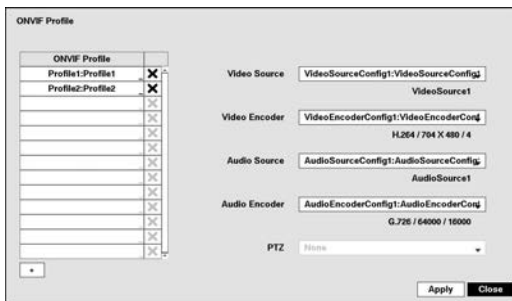

- ONVIF Profile: Adds or deletes an ONVIFTM profile.
- Video: Sets up the video source and encoder. The frame rate cannot exceed 15 ips when recording video with the H.264 codec and 4CIF resolution if the device is a network video transmitter.
- Audio: Sets up the audio source and encoder.

Network Setup

TCP/IP
IP Address Configuration

Type:

IP Address:

Default Gateway:

DNS Configuration

Type:

Domain Name:

Primary DNS:

Secondary DNS:

DDNS

Update Type:

Name:

TTL:

Zero Configuration

Zero Configuration

IP Address

Network Protocol

HTTP Server Port:

HTTPS Server Port:

RTSP Server Port:

WS-Discovery

Scope Parameters

omstf://www.omstf.org/type/hdco_encoder	<input type="checkbox"/>
omstf://www.omstf.org/type/audio_encoder	<input type="checkbox"/>
omstf://www.omstf.org/hardware/NC-B120	<input type="checkbox"/>

Discovery Mode: Discoverable

- TCP/IP: Sets up the device's IP address and DNS server.
- DDNS: Sets up the DDNS function.
- Zero Configuration: Automatically allocates an appropriate IP address for the current network conditions (supported only for devices that provide the function).
- Network Protocol: Changes the port numbers for the network protocols that are used in the device (supported only for the protocols that are used in the device).
- WS-Discovery: Sets up the WS-Discovery function.

I/O Setup

I/O

Name	Mode	Delay Time	Idle State	Action	Action
Alarm Out1	Bistable	0	Open	Active	InActive
				Active	InActive
				Active	InActive
				Active	InActive
				Active	InActive
				Active	InActive
				Active	InActive
				Active	InActive

- I/O: Sets up the input and output devices.

PTZ Setup

- PTZ: Sets up the PTZ.

Connector Pin Outs

I/O Connector Pin Outs

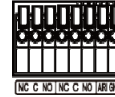

AI (1 to 16)	Alarm Inputs 1 to 16
GND	Chassis Ground (5 connectors)
NC	Relay Alarm Output (Normally Closed)
C	Relay Common
NO	Relay Alarm Output (Normally Open)
ARI	Alarm Reset In

RS485 Connector Pin Outs



Master Unit		Slave Unit	
+	→ To	→	TX+/ RX+
-	→ To	→	TX-/ RX-

Map of Screens

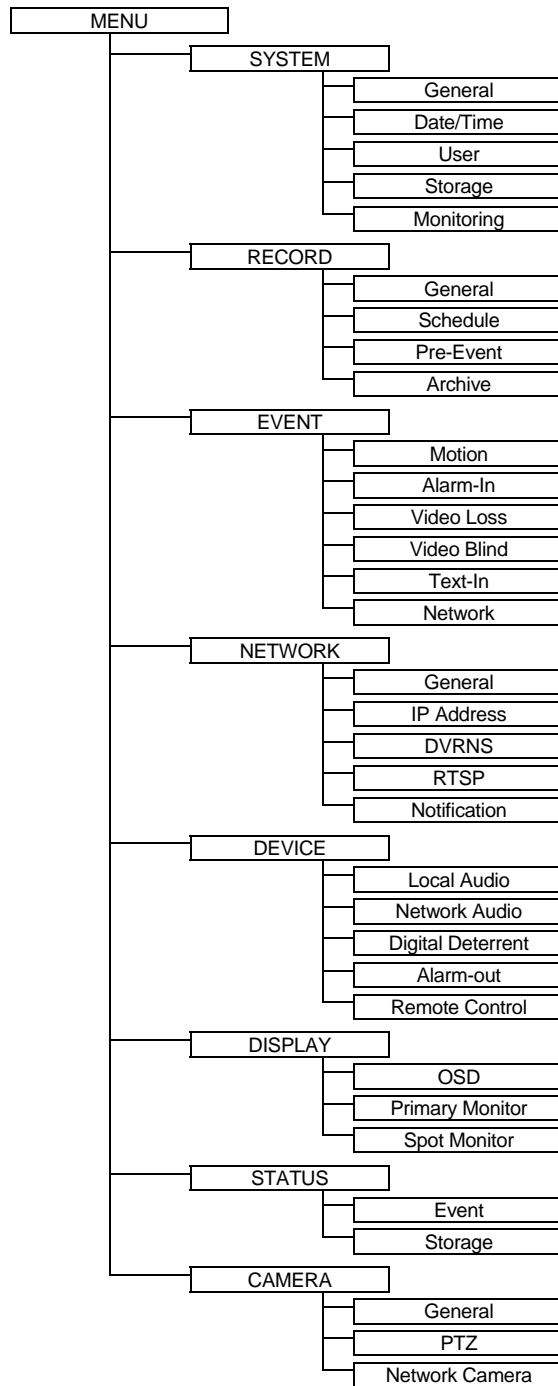

Error Code Notices





System Upgrade Related		Clip Copy Related	
No.	Description	No.	Description
0	Unknown error.	0	Unknown error.
1	File version error.	1	Device error.
2	Operating system version error.	2	Mounting failed.
3	Software version error.	3	No media.
4	Kernel version error.	4	Invalid media.
100	Upgrade device mounting failed.	5	File already existed.
101	Package is not found.	6	Not enough space.
102	Extracting package failed.	7	Creating temporary file failed.
103	LILO failed.	8	Opening disk failed.
104	Rebooting failed.	9	Formatting disk failed.
105	Invalid package.	10	Database has been changed.
106	ODD firmware upgrade failed.	11	Appending failed.
300	Remote connection failed.	12	Bad sector.
301	Remote network error.	13	No executable file.
302	Remote upgrade is not authorized.	14	Opening executable file failed.
303	Saving remote package failed.	15	Writing executable file failed.
304	Remote upgrade is cancelled by the user.	16	Creating image failed.
400	USB device mounting failed.	17	Burning failed.
401	Reading upgrade package on the USB device failed.	18	Burning is out of time.
402	Copying upgrade package on the USB device failed.	19	Connecting device failed.
403	USB device is not connected.	20	Device is busy.
404	USB device is being used.	21	Unsupported file system.
405	Unsupported file system.	22	Verify failed.
500	System is busy clip copying.	23	No Recorded Data

Connection Failure Related (Network Devices Only)			
No.	Description	No.	Description
0	Unknown case.	20	Connection has been canceled by user.
1	Normally logout.	21	Peer host does not respond.
2	Deny connection – all of server channels are used.	22	Network is too noisy.
3	Invalid product version.	23	Sending queue overflow.
4	Invalid user or password.	24	Invalid OEM number.
5	Admin close the current connection forcedly.	25	You have no authority for search.
6	Timeout.	26	Port is already in use.
7	Post system shutdown.	27	SSL connection failed.
8	Can't connect – all network channels are used.	28	Network is timed out.
9	Can't connect – no server module.	29	Host is timed out.
11	Network is down.	30	Host cannot support RTP over TCP.
12	Network is unreachable.	31	Socket error occurred.
13	Connection time out.	100	Unknown codec.
14	Connection reset by peer.	101	JPEG codec.
15	Host is down.	103	MPEG4 codec.
16	No route to host.	400	Not supported resolution.
17	Connection aborted.	-1	Connection normal.

System Log Notices

Boot Up	Setup Export Failure	Clip-Copy Fail
Shutdown	Setup Export Cancel	Clip-Copy User:
Restart	Schedule On	Clip-Copy From:
Upgrade	Schedule Off	Clip-Copy To:
Upgrade Fail	Panic On	Clip-Copy Duration of Video:
Power Failure	Panic Off	Clip-Copy Camera:
Time Change	Clear All Data	Callback Fail
Time Zone Change	Clear Disk	Print Begin
Time Sync	Format Disk	Print End
Time Sync Fail	Disk Full	Print Cancel
Disk Bad	Disk Config Change	Archive On
Login	No storage found	Archive Off
Logout	Disk Added	Mirror 1 (2) Started
Setup Begin	Disk Removed	Mirror 1 (2) Start Failed
Setup End	Auto Deletion	Mirror 1 (2) Stopped
Remote Setup Change	Search Begin	Mirror 1 (2) Stop Failed
Remote Setup Failure	Search End	Factory Reset
Setup Imported	Clip-Copy Begin	Login : VNC (server address)
Setup Import Failure	Clip-Copy End	Logout : VNC (server address)
Setup Exported	Clip-Copy Cancel	

Troubleshooting

Problem	Possible Solution
No Power	<ul style="list-style-type: none"> • Check power cord connections. • Confirm that there is power at the outlet.
No Live Video	<ul style="list-style-type: none"> • Check camera video cable and connections. • Check monitor video cable and connections. • Confirm that the camera has power. • Check camera lens settings.
Live Video Very Bright	If a cable is attached to the “Loop” connector, make certain it is connected to a properly terminated device.
DVR has stopped recording	If hard disk drive is full, you will either need to delete video or set the DVR to the Overwrite Mode.
The icon  displays, however, the DVR is not recording.	When the DVR is in the Pre-Event recording mode, the yellow  and  display when there is no event, and the DVR is not recording. The red  and  display when any event occurs and the DVR starts recording.
While upgrading the system, the DVR keeps rebooting and the upgrade fails.	If the current system version is higher than the upgrade package file version, you should reset the DVR first using the Factory Reset. When using the Factory Reset, you will lose any settings you have saved.

Specifications

VIDEO		
Signal Format	NTSC or PAL (Auto Detect)	
Video Input	Local	Composite: 8 or 16 looping inputs, 1 Vp-p, auto-terminating, 75 Ohms
	Network	4 network devices (100Mbps/1Gbps Ethernet)
Monitor Outputs	HDMI: 1 HDMI VGA: 1 SPOT: 1 BNC, 1 Vp-p, 75 Ohms	
Video Resolution	HDMI/VGA: 1920x1080p, 1920x1080i, 1280x1024, 1024x768 Composite (SPOT): 704x480 (NTSC), 704x576 (PAL)	
Record Speed (images per second)	Real-time: 480ips (NTSC), 400ips (PAL) @ 4CIF/960H (16-ch Model) 240ips (NTSC), 200ips (PAL) @ 4CIF/960H (8-ch Model) Network Device: 70ips @ 1920x1080 / 120ips @ 1280x720	
Playback Speed (images per second)	Full Duplex: 240ips (NTSC), 200ips (PAL) @ 4CIF/960H (16-ch Model) 120ips (NTSC), 100ips (PAL) @ 4CIF/960H (8-ch Model)	

INPUTS/OUTPUTS		
Alarm Input	8 or 16 terminal, programmable as NC or NO, 2.4V (NC) or 0.3V (NO) threshold, 5VDC	
Alarm Output	2 relay output, programmable as NC or NO, 2A@125VAC, 1A@30VDC	
Alarm Reset Input	1 TTL, terminal block	
Internal Buzzer	80dB at 10cm	
Network Connectivity	10Mbps/1Gbps Ethernet (RJ-45)	
Audio Input	Local	RCA Input, 4 Line In
	Network	4, 100Mbps/1Gbps Ethernet
Audio Output	RCA Output: 1, Line Out	
Text Input	POS Interface, ATM Interface	

CONNECTORS		
Video Input	Local	Composite: 8 or 16 BNC
	Network	RJ-45 (100Mbps/1Gbps Ethernet)
Video Loop	Composite: 8 or 16 BNC (Auto Terminating)	
Monitor Output	HDMI: 1 HDMI VGA: 1 VGA SPOT (Composite): 1 BNC	
Audio In	Local	4 RCA connector
	Network	RJ-45 (100Mbps/1Gbps Ethernet)
Audio Out	1 RCA connector	
Alarm Input/Output	Terminal Blocks	
Ethernet Port	1 RJ-45	
eSATA Port	eSATA	
RS232C Serial Port	DB9 (P)	
RS485 Serial Port	Two-connector terminal block	
IR Port	1 Remote Control	
USB Port	2 (USB 2.0)	

STORAGE		
Primary Storage	SATA hard disk drive (up to 4) (up to 3 with an internal DVD RW drive)	
Secondary Storage*	eSATA hard disk drive (RAID) Built-in DVD RW drive USB hard disk drive or flash drive	

* When installing an internal DVD RW drive, connect the SATA I/O cable to the SATA ODD socket.

GENERAL	
Dimensions (W x H x D)	16.9" x 3.5" x 15.7" (430mm x 88mm x 400mm)
Unit Weight	17.9 lbs. (8.1kg)
Shipping Weight	24.5 lbs. (11.1kg)
Shipping Dimensions (W x H x D)	21.3" x 11.4" x 23.2" (540mm x 290mm x 590mm)
Operating Temperature	41°F to 104°F (5°C to 40°C)
Operating Humidity	0% to 90%
Power	100 to 240 VAC, 1.2 – 0.6 A , 50/60Hz
Power Consumption	Max. 46W
Approvals	FCC, UL**, CB, CE

** CAUTION: Risk of Explosion if Battery is replaced by an Incorrect Type. Dispose of Used Batteries According to the Instructions. This equipment is indoor use and all the communication wiring are limited to inside of the building.

Specifications are subject to change without notice.